



SOUTHERN CALIFORNIA
EDISON[®]

Energy for What's Ahead[®]

NET ENERGY METERING

Interconnection Handbook

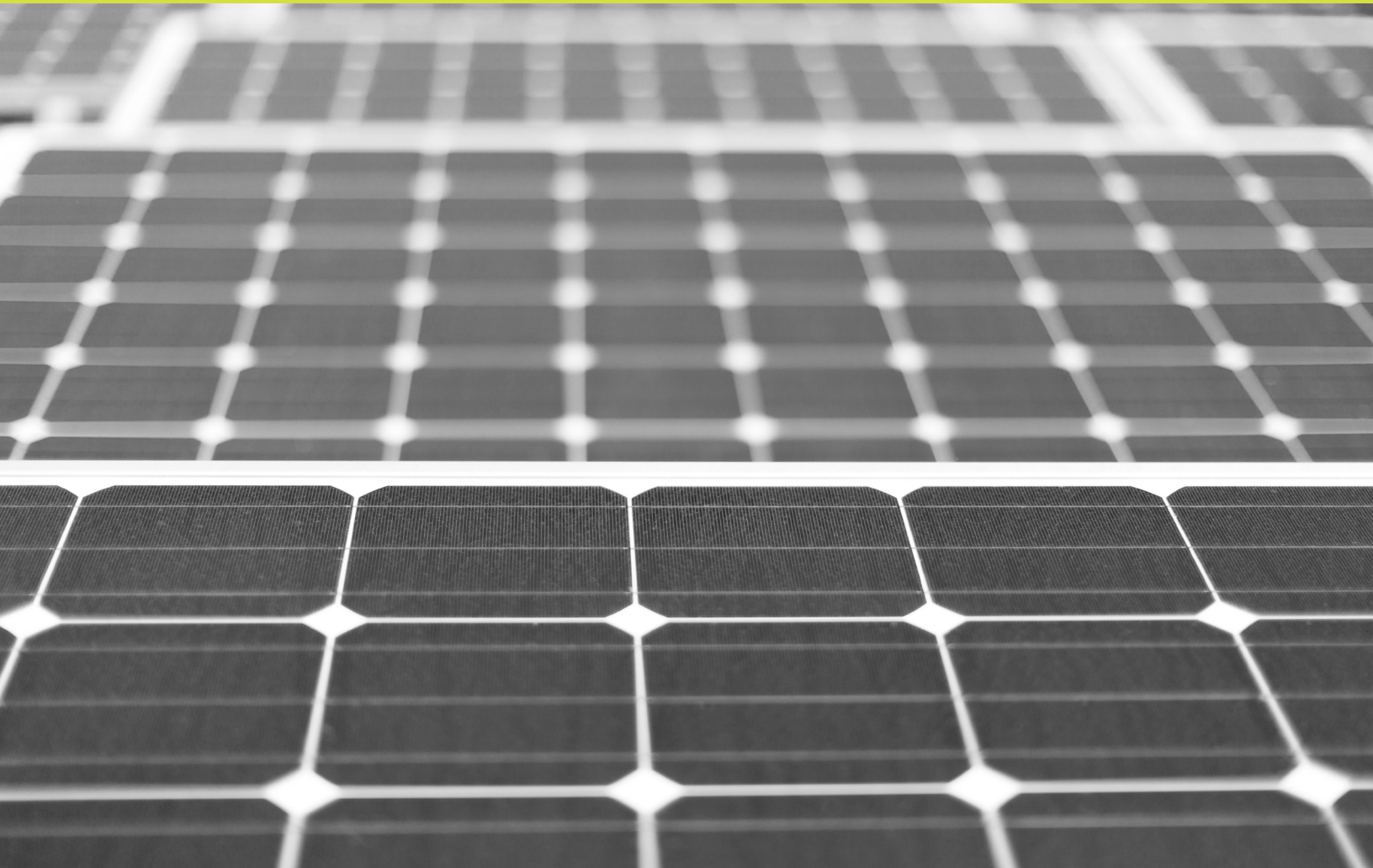

How to use this interactive PDF

- Use the interactive table of contents to select topics and navigate
- Alternatively, you may scroll through the document page by page
- To search the document: Windows: Ctrl+F, Mac: ⌘ +F

Version 9.0



WHAT'S NEW

Effective Date: July 2022

This handbook has been reorganized from the previous version and the following additional information has been added and/or modified:

- Section 5.5.1 Visible Open AC Disconnect Switch Requirements Voltages 34.5 kV or below
- Section 5.5.8 Remote Control Equipment
- Section 6.1 Sizing Requirements for NEM Interconnection with Paired Energy Storage
- Section 6.2 Options and Metering Requirements for NEM-Paired Storage Systems
- Section 6.5 Certified Control Systems for NEM-Large Paired Storage Systems
- Section 8 Generation Meter Adapter (GMA)
- Section 9.5 Telemetry
- Section 10.2 Variance for AC Disconnects
- New Section 10.3 Unique address for New meter electrical service panel and Net Generation Output Metering (NGOM) panel(s)
- New Section 10.4 Meter Spot Request Process
- New Section 10.5 Meter Lock Ring Removal Process
- Appendix D – Inverter Settings Request

TABLE OF CONTENTS

1 Overview

1.1 Eligible Customer-Generators with NEM special conditions are required to comply with NEM-ST.....	6
--	---

2 Reference Information

2.1 Application Requirements.....	8
2.2 Equipment Information	8
2.3 Calculations.....	9

3 Interconnection Review Process

3.1 Document Review	11
3.2 SCE Witness of Commissioning Test	11
3.3 Interconnection Study.....	12
3.4 Review Fees	13

4 Operating Evaluations

4.1 Normal Voltage Operating Range	15
4.2 Limits Specific to Single-Phase Generating Facilities.....	15
4.3 Limits Specific to Three-Phase Generating Facilities.....	15

5 General Requirements

5.1 Inverter	16
5.2 Single Line Diagram.....	17
5.3 Line-Side Taps.....	18
5.4 Plot Plan Requirement	21
5.5 AC Disconnect Requirements	21
5.5.1 Visible Open AC Disconnect Switch Requirements Voltages 34.5KV or below	21
5.5.2 Frequently asked questions on AC Disconnects	22
5.5.3 AC Disconnect Type and Location Requirements	22
5.5.4 Self-Contained Meter ⁴ with One Main Switch.....	23
5.5.5 Non-Self-Contained Meter – Secondary Voltage Connection	25
5.5.6 Primary Service Voltage Connections.....	26
5.5.7 Circumstances when AC Disconnect May be Opened by SCE	27
5.5.8 Remote Control Equipment.....	28

6 Paired Storage Requirements

6.1 Sizing Requirements for NEM Interconnection with Paired Energy Storage30
6.2 Options and Metering Requirements for NEM-Paired Storage Systems30
6.3 Non-Export Relay for NEM-Large Paired Storage Systems.....31
6.4 Net Generation Output Meter (NGOM) for NEM-Large Paired Storage Systems.....32
6.5 Certified Control Systems for NEM-Large Paired Storage Systems.....33
6.6 Maximum Continuous Discharge Sizing Option for NEM-Large Paired Storage Systems.....33

7 Net Generation Output Meter (NGOM)

7.1 General Requirements for NGOM's.....35
7.2 Technical Requirements for NGOM's.....36
7.2.1 Single Line Diagram Requirements for NGOM's.....37
7.2.2 Plot Plan Requirements for NGOM's.....37
7.2.3 AC Disconnect Requirements for NGOM's.....37
7.2.4 Virtual NEM NGOM Installation.....39

8 Generation Meter Adapter (GMA)

8.1 General Requirements for GMA's41
8.1.1 Documentation Requirements for GMA's42
8.1.2 Eligible Service Panels for GMA Installations42
8.1.3 Ineligible Service Panels for GMA Installations.....43
8.2 Technical Requirements for GMA's.....43
8.2.1 Single Line Diagram Requirements for GMA's.....43
8.2.2 Plot Plan Requirements for GMA's44
8.2.3 AC Disconnect Requirements for GMA's.....44
8.2.4 Grounding Customer Systems Downstream of GMA.....45

9 Protection Requirements

9.1 Protection Requirements.....46
9.2 Inverter Protection Settings.....47
9.3 Ground-Fault-Sensing and Stabilization47
9.4 Secondary Network Interconnection47
9.5 Telemetry48

10 Additional Requirements

10.1 Plug-In Generation Facilities to Electrical Wall Outlet.....	49
10.2 Variance for AC Disconnects.....	49
10.3 Unique Address for New Meter Electrical Service Panel and Net Generation Output Metering (NGOM) panel(s).....	50
10.4 Meter Spot Request Process	50
10.5 Meter Lock Ring Removal Process	51

11 Definitions

11.1 Definitions.....	52
11.2 Acronyms.....	53

Appendix

Appendix A: Sample Single Line Diagram	55
Appendix B: Sample Single Line Diagram for GMA installations	56
Appendix C: Sample Plot Plan.....	57
Appendix D: Inverter Settings Request.....	58
Appendix E: Maximum Borderline of Irritation Curve.....	59
Appendix F: Supply Side / Line Side connections	60
Appendix G: Net Generation Output Meter (NGOM) Panel EUSERC Drawing Number Guide Table.....	62

(1) OVERVIEW

A generating facility may not be operated in parallel with SCE's Distribution System UNTIL WRITTEN PERMISSION TO OPERATE IS GRANTED BY SCE, as required in SCE's [Rule 21](#) (PDF). Unauthorized operation may be dangerous and may result in injury to persons and/or may cause damage to equipment and/or property for which the customer may be liable.

This NEM Interconnection Handbook specifies the typical minimum technical requirements to interconnect generating facilities with SCE's electric system under the Net Energy Metering (NEM) program. These requirements are necessary to ensure the safe and reliable operation of SCE's electric system.

These requirements apply to the interconnection of a generating facility to SCE's electrical Distribution System through the NEM program under the following SCE rate schedules:

- [Schedule NEM-ST](#) (PDF): Net Energy Metering (including NEM Aggregation and Multiple Tariff)
- [Schedule FC-NEM](#) (PDF): Fuel Cell Net Energy Metering
- [Schedule NEM-V-ST](#) (PDF): Multi-Tenant, Multi-Meter Virtual Net Metering
- [Schedule SOMAH-VNM-ST](#) (PDF): Solar on Multi-Family Affordable Housing Virtual Net Metering
- [Schedule MASH-VNM-ST](#) (PDF): Multi-Family Affordable Solar Housing Virtual Net Metering

(Note: SCE is no longer accepting MASH-VNM-ST applications due to program phase out)

This handbook does not address other types of generator interconnections under [Rule 21](#) (PDF) or the [Wholesale Distribution Access Tariff \(WDAT\)](#). Note: [Schedule RES-BCT](#) (PDF) (Renewable Energy Self-Generation - Bill Credit Transfer) is addressed under [Rule 21](#). For technical requirements for interconnection under [Rule 21](#) (PDF) or [WDAT](#), please refer to [SCE's Interconnection Handbook](#) (PDF).

Under the NEM program ([CPUC § 2827](#)), customers installing generating facilities are eligible to interconnect if the generating facility is located on the customer's premises, generates electricity from a renewable source pursuant to paragraph (1) of subdivision (a) of Section 25741 of the Public Resources Code (i.e., biomass, solar thermal, photovoltaic, wind, geothermal, fuel cells using renewable fuels, small hydroelectric generation, digester gas, municipal solid waste conversion, landfill gas, ocean wave, ocean thermal, or tidal current), fuel cells or biogas, or a hybrid of these technologies, and is sized to offset all or part of the customer's electrical requirements. NEM 2.0 generating facilities with a gross name plate rating larger than 1 MW, NEM Aggregation requesting a new service, or NEM Aggregation retrofitting an existing service panel on a distribution circuits may require additional studies or be part of the Distribution Group Study at the customer's expense. Reference [Rule 21](#) section F.3.C. To deliver incidental power to the grid, a customer's generating system must be located

(1) Overview

on the customer's premises and be interconnected to SCE's electrical system, i.e., permanently connected to allow "parallel operation" with the utility grid.

1.1 Eligible Customer-Generators with NEM special conditions are required to comply with NEM-ST

(reference [Schedule NEM-ST](#), Net Energy Metering Successor Tariff)

- California Department of Corrections and Rehabilitation (CDCR) generating facilities from 1 MW and not exceeding 8 MW.
- U.S. Armed Forces limited to the lesser of 12 MW or 1 MW over minimum load over the preceding 36 months.

Note: An adjustment will be made by SCE, using existing telemetry data where available or information provided by the customer, to account for load served by existing on-site generation (so that the determination of minimum load is not reduced by on-site generation). SCE may make additional adjustments, if necessary, to account for anomalies, such as outages, and may rely on mode minimum load registrations, daytime minimum load registrations, or other methods to reasonably determine the customer's minimum load for the sole purpose outlined above. A customer's minimum load determination shall only be updated at the request of the customer or any time a new NEM Interconnection Request for the United States Armed Forces base or facility is submitted.

NOTE: The NEM tariff is applicable for renewable electrical generating facilities that are intended primarily to offset part or all of the customer's own electrical usage and must be located on the customer's Premise. For generating facilities utilizing fuel cell technology that qualifies as renewable, the total Renewable Electrical Generating Facility's capacity must not exceed 5 MW CEC-AC Nameplate rating and the lesser of 5 MW aggregate inverter capacity or 5 MW aggregate Fuel Cell gross nameplate capacity and must be located on the customer's Premise.

(2) REFERENCE INFORMATION

2.1 Application Requirements

At www.sce.com/nem, SCE provides information about the NEM Program, NEM-ST Rate Schedules and required forms. Additionally, there is an [Application Checklist](#), a sample Single Line Diagram and Plot Plan available for download.

NEM applicants are now required to use SCE's NEM online interconnection [SCE's NEM Online Interconnection Application System](#) to submit an Interconnection Request (IR). Please access the online application system to view the status of an IR or submit additional documentation.

2.2 Equipment Information

Table 2.2-1: Equipment Listings

Equipment	Equipment Listings
Grid Support Inverters	https://solarequipment.energy.ca.gov/Home/InvertersList
Solar PV Modules	https://solarequipment.energy.ca.gov/Home/PVModuleList
Wind Turbines & Fuel Cells	Renewables Portfolio Standard - RPS California Energy Commission
Battery & Energy Storage Systems	Battery List: https://solarequipment.energy.ca.gov/Home/BatteryList ESS List: https://solarequipment.energy.ca.gov/Home/PropertyDetails/EnergyStorage
Power Control System	https://solarequipment.energy.ca.gov/Home/PowerControlSystem

NOTE: The certification listings above identify some of the electrical components of a generating facility. These components must be incorporated in the generating electrical design and shown on the Single Line Diagram (SLD) to ensure that the generating facility as a whole is compliant with the NEM tariff requirements.

If the proposed equipment is not listed on the certified equipment list, UL Certification of the equipment will need to be submitted to the CEC to be verified and added to the online listing. See [Section 5](#) for details.

(2) Reference Information

2.3 Calculations

For the purposes of the NEM Interconnection Application, the following formulas are used to calculate CEC-AC nameplate system size (kW) and estimated monthly kWh output:

Table 2.2-2: CEC-AC Nameplate Calculation for Inverter based Generation Facilities

Technology	CEC-AC Nameplate Calculation
Solar PV	$(\text{Qty of PV Modules}) \times (\text{PTC Rating}) \times (\text{Inverter Efficiency \%}) / 1000 = \text{___ kW}$
Wind	$(\text{Qty of Turbines}) \times (\text{Power Output}) \times (\text{Inverter Efficiency \%}) / 1000 = \text{___ kW}$
Fuel Cell	$(\text{Qty of Cells}) \times (\text{Rated Output}) \times (\text{Inverter Efficiency \%}) / 1000 = \text{___ kW}$

Table 2.2-4: Estimated Annual kWh Calculation

Technology	Estimated Annual kWh
Solar PV	Use the CSI EPBB calculator at www.csi-epbb.com or: $(\text{CEC-AC Nameplate}) \times 720 \times 0.20 \times 12 = \text{___ kWh}$
Wind	$(\text{CEC-AC Nameplate}) \times 720 \times 0.15 \times 12 = \text{___ kWh}$
Fuel Cell	$(\text{CEC-AC Nameplate}) \times 720 \times 0.85 \times 12 = \text{___ kWh}$

NOTE: Both the CEC-AC rating and the aggregate inverter capacity must be \leq than 1 MW for a generating facility to be considered 1 MW or smaller.

(3) INTERCONNECTION REVIEW PROCESS

After an initial review to confirm the Application and SLD are complete and consistent with interconnection requirements, the NEM Interconnection team may refer the project for technical review and approval. Upon referral, the installer is provided notice and contact information for the engineer assigned to the project. At SCE's discretion, an onsite inspection and commissioning test may be required as part of the technical review – see [Section 3.2](#) for more detailed information.

The design must be in accordance with:

- SCE's Electric [Rule 21](#) (PDF)
- SCE's [Electric Service Requirements \(ESR\)](#) (PDF)
- SCE's [Interconnection Handbook](#) (PDF)
- NFPA's [National Electric Code](#), and
- All applicable local codes and ordinances

The purpose of the technical review is to facilitate the safe interconnection of eligible NEM generators to the SCE electrical Distribution System. To ensure the generator interconnection is in compliance with SCE interconnection requirements, the customer's generating facility will, at a minimum, be reviewed to ensure that the generating facility will:

- Not unintentionally operate in an islanded mode with SCE's electrical system as required by [IEEE 1547](#), UL 1741, and UL1741-SA
- When required, have a visible open, lockable disconnect switch and/or rackable breaker for isolation purposes, comply with [Rule 21](#) and SCE's [Electric Service Requirements \(ESR\)](#)
- When required, have the required relay or control equipment and set as required to meet NEM requirements

If the generating facility exceeds the operating capabilities of the Distribution System relative to voltage control, system overload, system operating flexibility or other system condition, it will be required to mitigate such condition prior to SCE providing technical approval. An NEM customer must bear the cost of the Interconnection Facilities and distribution upgrades as may be applicable. **Please refer to Decision 02-03-057, Rule 21, Section E.4., and Public Utilities Code Section 2827(g) for the delineation of cost responsibilities for Distribution Upgrades versus Interconnection Facilities.** Failure to comply with all the requirements in this section may result in potential delays. If the review determines corrections are needed, they must be completed prior to the Permission to Operate (PTO) being issued and the customer is responsible for all costs.

(3) Interconnection Review Process

3.1 Document Review

The following documents are required before SCE will begin the technical review of a proposed generating facility:

- Completed online application Form: See NEM Interconnection Checklists at sce.com/nem
- Single Line Diagram: see [Section 5](#) for detailed requirements and [Appendix A](#) for a sample
- Photos of the AC Disconnect Switch (and overcurrent protection): See [Section 5](#) for requirements.

The following additional information may also be required based on the size/configuration of the proposed system:

- Smart Inverter Specifications and smart inverter settings: See [Section 5](#) for more information;
- Plot Plan: See [Section 5](#) for circumstances when a Plot Plan is required and Appendix C for a sample.
Note: A Plot Plan is required whenever an AC disconnect is required.
- Net Generation Output Meter (NGOM) installations: See [Section 7](#) for additional documentation required.
- Generation Meter Adapter (GMA) installations: See [Section 8](#). for additional documentation required.
- Line Side / Supply Side Taps: See [Section 5](#) & [Appendix F](#).
- If transformers are used to interconnect the Generating Facility with SCE's Distribution System, please provide the transformer nameplate information (e.g., voltages, capacity, winding arrangements, connections, impedance).
- If a transfer switch or scheme is used to interconnect the Generating Facility with SCE's Distribution System, please provide component descriptions, capacity ratings, and a technical description of how the transfer scheme is intended to operate.
- If protective relays are used to control the interconnection, please provide protection diagrams or elementary drawings showing relay wiring and connections, proposed relay settings, and a description of how the protection scheme is intended to function: See [Section 6](#) for more information.
- All projects utilizing a Power Control Systems must comply with NST Tariff – Section 6.B.II.A for UL 1741 Certification Requirement Decision.

3.2 SCE Witness of Commissioning Test

SCE intends to conduct a witness test and onsite inspection for a specific set of projects that meet criteria outline below. When a witness test is required, a representative of the installer qualified to operate the equipment must be present.

(3) Interconnection Review Process

Before a witness test will be scheduled, SCE requires a copy of the Electrical Inspection Release from the appropriate Authority Having Jurisdiction (e.g., final inspection job card from the local building and safety department) to ensure that the work on the customer's side of the meter has been permitted, meets the requirements of the [National Electric Code](#), applicable local codes and ordinances, and is therefore safe to energize.

The onsite inspection will ensure that the installation reflects what is shown on the single line diagram and the documents provided by the applicant for the generating facility. Requirements such as [Rule 21](#), Section H or Section Hh, voltage and power flow control will be tested and verified during the commissioning test.

When an onsite inspection is required, the customer must request such inspection and must have a Commissioning test procedure at minimum 10 days in advance as required in Rule 21 section L.5.

SCE requires an SCE engineer to be present and witness the commissioning test of projects that fit the description of any of the criteria below:

- Projects that utilize relay(s) or control system(s).
- Projects that require or rely on the use of Distribution Equipment
- Projects whereby harmonic evaluation needs to occur
- Projects where customer has not provided sufficient information for SCE to verify the compliance requirements

NOTE: SCE reserves the right of witnessing the commissioning test of any project. Regardless of the outcome of the commissioning test, the customer is not authorized to energize the system until SCE issues a Permission to Operate (PTO) Letter. Once the assigned Engineer returns the project to the NEM IC group, PTO will typically be issued within five business days.

SCE may waive the witness of commissioning requirements if there is means to verify the requirements through the submittal of documentation (E.g. Specifications, Photos).

3.3 Interconnection Study

If, during the Initial and Supplemental reviews, it is determined that an interconnection study is required, SCE will perform the study in accordance with [Rule 21](#) timelines. The interconnection study will detail any additional Interconnection Facilities and/or Distribution Upgrades that will be needed to accommodate the Applicant's generating facility. If the generating facility exceeds the operating capabilities of the Distribution System relative to voltage control, system overload, system operating flexibility or other system condition, it will be required to mitigate such conditions prior to SCE providing technical approval. In addition, SCE may

(3) Interconnection Review Process

require that the customer performs a harmonic study during the execution and implementation phase of the project. This will ensure that the generating facility will comply with IEEE 519-2014 Harmonic Current Limits. For projects with a net AC output or CEC-AC net output over 1 MW and NEM Aggregation projects, the customer is responsible for paying all triggered upgrades and related studies.

3.4 Review Fees

Application fees for NEM Successor Tariff vary depending on the generating capacity of the system. The application fees are as follows:

- Less than 1 Megawatt (MW) - \$75
- Greater or equal to 1MW - \$800

NOTE: Both the CEC-AC rating and the aggregate inverter capacity must be \leq than 1 MW for a generating facility to be considered 1 MW or smaller.

(4) OPERATING EVALUATIONS

The generator operator/customer may operate the generating facility during grid power interruption only when the customer facility has been electrically isolated from the grid via opening the customer's main breaker or other applicable device. All required settings (such as anti-islanding, volt/var, and volt/watt) must be activated prior to reconnection to the distribution grid. SCE may specify additional commissioning test requirements for generating facilities with capabilities to operate islanded.

Islanding¹ with SCE systems will not be permitted under any circumstance.

Technical Approval of the generating facility is based on the [Rule 21](#) Fast Track initial review screens that include the following criterias:

- **Generating Facility capacity on the line section is less than 15%:** the Applicant's generating facility combined with existing generation does not exceed 15% of the maximum loading of the line section. For more information, please refer to [Rule 21](#), Section G.1.m.
- **Overloading:** all distribution equipment must not be overloaded by the generating facility.
- **Voltage Operating Levels:** the Applicant's generating facility must not create a voltage drop or rise that is outside the allowable operating-voltage bandwidth specified in [Rule 21](#) and [Rule 2](#) (PDF).
- **System Upgrades:** upon review by SCE, system upgrades may be required to allow the system to accommodate the interconnection of the generating facility.
- **Harmonics:** All equipment connected to the SCE distribution system, will be subjected to CPUC Rule 2.E. allowing SCE to require the IC to mitigate interference with service other SCE customers, including harmonics impacts, if the harmonics interference is caused by the Interconnection Customer.

Please refer to [Section 3](#) for the delineation of cost responsibilities for Distribution Upgrades versus Interconnection Facilities.

NOTE: For technical analysis defined in this Handbook, SCE will use the Aggregate Inverter Capacity.

Following a generation facility disconnect as a result of a voltage or frequency excursion (parameters are described in [Rule 21](#) Section H 1 & H 2. a. 2), the generation facility must remain disconnected from the grid until the service voltage and frequency has recovered to SCE's acceptable voltage and frequency limits outlined in [Rule 21](#).

¹ Rule 21, Section C, Definitions.

(4) Operating Evaluations

4.1 Normal Voltage Operating Range

To minimize the adverse voltage effects experienced by other customers on SCE's electric system, any voltage flicker at the point of common coupling (PCC) caused by the generating facility must not exceed the limits defined by the "[Maximum Borderline of Irritation Curve](#)" shown in the Institute of Electrical Engineers (IEEE) 519, [Rule 2](#) (PDF), and [Rule 21](#) (PDF).

4.2 Limits Specific to Single-Phase Generating Facilities

When multiple 120V generators are connected to a single phase 120/240V Transformer, the generators must be installed such that the gross output is balanced between the two 120V service connection points (legs). In addition, the maximum aggregated Gross Ratings for all the Generating Facilities shall not exceed the transformer rating(s).

4.3 Limits Specific to Three-Phase Generating Facilities

The applicant must balance the demand load and generation as nearly as practical between the two sides of a three-wire single-phase service and between all phases of a three-phase service.

The difference in amperes between any two phases at the customer's peak load should not be greater than 10 percent or 50 amperes (at the service delivery voltage), whichever is greater; except that the difference between the load on the lighting phase of a four-wire delta service and the load on the power phase may be more than these limits. It is the responsibility of the customer to keep the demand load balanced within these limits.

(5) GENERAL REQUIREMENTS

5.1 Inverter

An inverter-based generating facility must meet all required criteria specified in SCE's "[Rule 21](#) - Generating Facility Interconnections," [IEEE 1547](#), UL 1741, UL 1741 SA, and [SCE's Interconnection Handbook](#) (PDF).

- Customers interconnecting inverter-based Generating Facilities are required to comply with the requirements of Section Hh of SCE's Electric [Rule 21](#), including configuration protective settings in accordance with the specification therein. Verification of compliance with such requirements shall be provided by the customer upon request by SCE in accordance with SCE's [Rule 21](#).
- Installers /developers are responsible to comply with contractual agreement by programming smart inverter following manufacturer guidelines.
- Failure to comply with Section Hh of SCE's [Rule 21](#), and Section 4.8 of the Interconnection Agreement may result in possible delays and it will affect the timing for providing PTO.

Inverters listed on the "Grid Support Inverters List" and "Energy Storage" of the [California Energy Commission](#) website have been verified to be certified with the latest UL 1741, UL1741 SA-Listed, and [IEEE 1547](#) standards:

- Underwriters Laboratories Standard UL 1741 and UL1741 SA certification, or

Separate single-unit or multiple-unit inverters that do not meet UL 1741 and UL1741 SA certification will not be granted commercial operation status and the customer will not be permitted to interconnect to SCE's electrical Distribution System.

SCE reserves the right to disconnect previously certified interconnected units when Underwriters Laboratories decertifies the units. SCE may implement an acceptable mitigation procedure for recertification at the customer's expense.

(5) General Requirements

5.2 Single Line Diagram

See [Appendix A](#) for a sample Single Line Diagram.

The Single Line Diagram shows the comprehensive path and graphic symbols of the entire electrical system for the site to provide a good understanding of the connections and component use. “Best” single lines provide, on one side of the page, a sequence of events such as what happens during an SCE interruption and which devices close and/or open to return the generating facility to normal status. Any and all additional information necessary to demonstrate compliance with [Rule 21, SCE’s Interconnection Handbook](#) and SCE’s [Electrical Service Requirements](#) (ESR) should be provided.

Depending on the system, the following should be included on the Single Line Diagram:

- Site location/service address (must match address on SCE account and NEM Interconnection Application);
- Details of point of connection to the power grid, specifically showing whether it is on the utility or customer side of the main breaker. Include the line of demarcation between SCE & customers’ section;
 - Line Side Taps – See [Section 5](#);
 - Generation Meter Adapters (GMAs) – See [Section 8](#). & [Appendix B](#);
- Service Panels;
- Protective devices: Circuit Breakers, Fuses, CT and PT ratings, if applicable;
- Utility meter and meter #;
- Projects including Net Generation Output Meters (NGOMs) – See [Section 7](#);
- Make and model of all generators on site including existing equipment; Detailed component information (characteristics) included for each component (Voltage and phase of inverters, transformers, etc.);
- Naming convention of system components consistent with the Plot Plan and other documentation.
- Other types of generation and system size, such as paired storage devices, emergency battery backup, diesel generators, permanently connected generators, etc. including their related interconnection equipment such as open transition transfer switches, relays and certified control systems.
- Manual, visibly, lockable, and physically open AC disconnect switch, including make and model (all info outlined in proposed SLD) – see [Section 5](#) for Manual, Visibly, Lockable, and physically open AC Disconnect requirements;
- Code and version to be used for construction, repair, inspection and testing.

If you come across a broken meter seal, report it immediately to 1-800-655-4555.

(5) General Requirements

5.3 Line-Side Taps

A Line Side Tap is when the generating facilities' POI (Point Of Interconnection) to the power grid is on the utility side of the customer owned/operated main breaker. SCE considers the Line Side Tap method of interconnection to be a potential safety issue because modifications of the customer's electrical service equipment could compromise the UL certification, as well as the ratings and withstand capabilities that the electrical service equipment was originally designed for. SCE strongly encourages the customer to evaluate and connect the generating facility to the load side of the main circuit breaker in accordance with the original intent of the existing electrical service equipment.

When the method of interconnection is a line side tap, this signifies that the generating facility electrical point connection to the power grid is on the utility side of the customer owned/operated main breaker. The following additional requirements must be met and or submitted to SCE prior to PTO:

1. A SLD that includes the following items (in addition to the requirements mentioned in [Section 5](#)):
 - Signed PE Stamp
 - Protective device information (fused AC Disconnect)
 - Line of demarcation between SCE's section and the Customers' section
 - Callout indicating "Line Side Tap"
2. A Plot Plan that includes the following items (in addition to the requirements mentioned in [Section 5](#)):
 - SCE Meter
 - Point of Generating facility electrical connection (line side tap connection point)
 - Fused AC Disconnect Switch (Located directly adjacent to the line side tap connection point if possible)
 - > See [Section 5](#) for fused AC disconnect location requirements
 - > See [Section 10](#) for AC disconnect variance requests if unable to meet location requirements listed in [Section 5](#)
3. Multiple photos of the Fused AC Disconnect Switch that shows it's lockable in the open position and contacts have visible separation in the open position (please refer to [Section 5](#) for further clarification).
4. Multiple photos and/or vendor drawings of the intended line side tap connection point that include the following items:
 - Callouts of intended modifications to existing equipment to accommodate the line side tap
 - SCE Metering Section
 - SCE CT Section
 - SCE Pull Section
 - Intended line side tap connection point
 - Conductor routing
 - Close up views
 - Views including the surrounding area
5. Signed Final Inspection from the local building and safety department or AHJ
6. Submittal of documentation for Verification of Compliance ([Appendix F](#) / Line Side Tap Letter)

It is in violation of SCE's ESR to modify, reduce, or infringe on utility-compartment space, or reduce any clearances. Please refer to restrictions below and SCE's ESR to develop a line side tap proposal.

(5) General Requirements

NOTE: Line Side Tap locations and construction methods (Item 3) must be reviewed and accepted by SCE on a project by project basis during NEM application review. After the assigned SCE engineer has reviewed and accepted a customer's line side tap location and construction methods (in addition to verification and acceptance of items 1 – 3), a communication will be sent to the customer/installer indicating the project is "Pending Applicant Construction". After this communication has been received, the customer may schedule an outage by contacting their local SCE Planning Office (see contact information below). See SCE ESR for planning office phone numbers

To find the local SCE Planning Office (Service Center) contact information please lookup the city in Table 1-2 (SCE's [ESR-1](#) Section 2) to identify the appropriate Service Center. Then lookup the corresponding Service Center in Table 1-1 (SCE's [ESR-1](#) Section 2) to identify the phone number.

Restrictions:

This section identifies several relevant sections of SCE's [ESR](#). Please reference [Figure 1](#) below for an example of an acceptable line side tap.

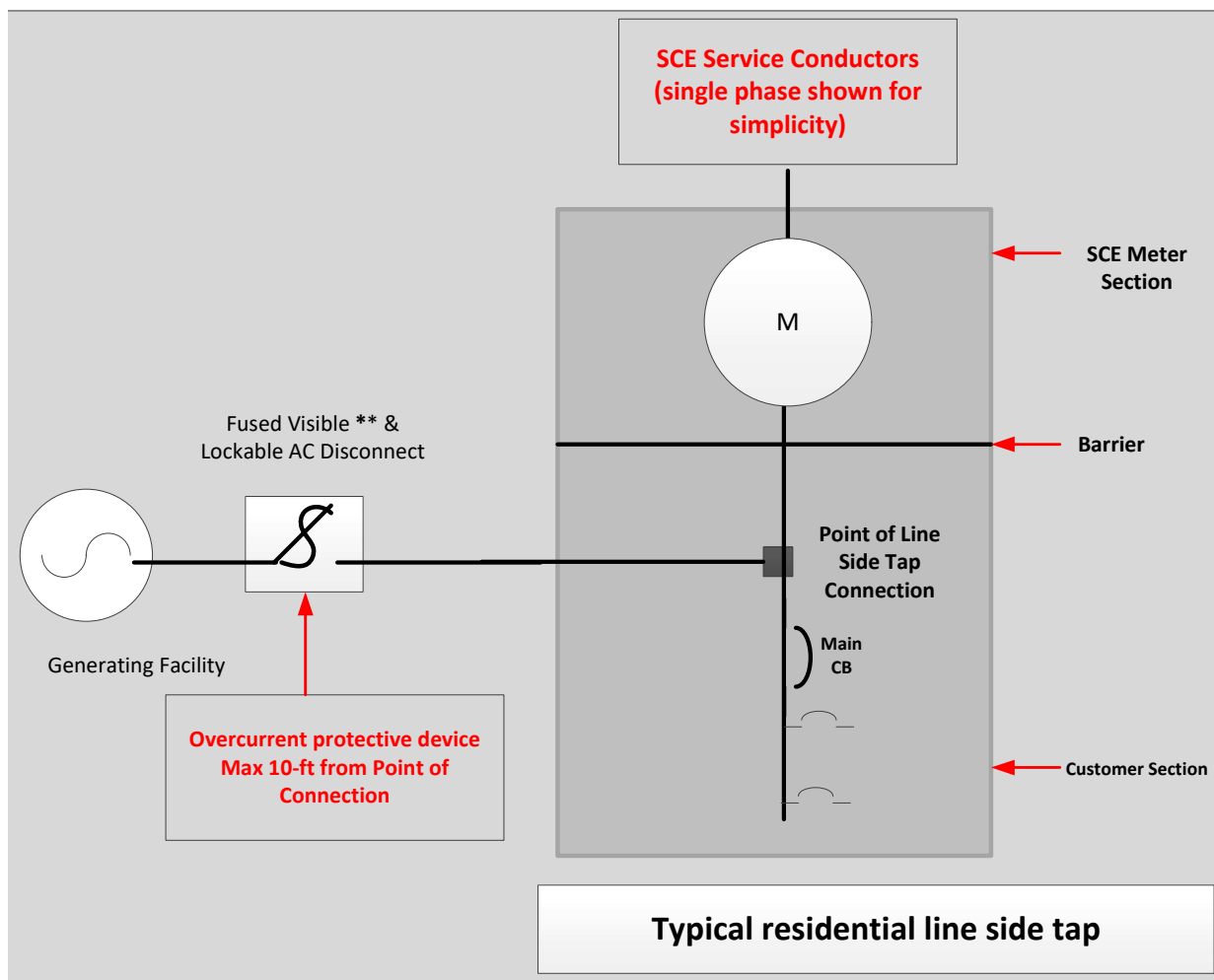

Figure 1 – Acceptable Line side tap Connection

(5) General Requirements

Line Side taps may not be made inside any SCE sealed sections of service equipment including but not limited to:

- SCE Metering Section
- SCE CT Section
- SCE Pull Section

CAUTION ABOUT BROKEN METER SEALS:

Per **ESR-5**, Section 1.0, (pg. 5-5), all enclosures and raceways on the line side (unmetered) or housing metering equipment shall be sealable. Meter seals shall not be broken by anyone except an authorized SCE employee.

Per **ESR-6**, Section 1.0 (pg. 6-3), conductors shall not be rerouted through any metering compartment. Fused and unfused conductors shall not occupy the same raceway unless they are completely barriered from each other in a manner acceptable to SCE.

Per **ESR-6**, Section 5.0, Figure 6-8 (pg. 6-17), except for conductors supplying the instrument-transformer compartment and the ground bus, no other conductors or devices shall be installed in, or routed through, the compartment or the sealed area above the compartment. The ground bus shall not infringe on utility-compartment space, or reduce any clearances. Customer connections to the ground bus shall be allowed in the instrument transformer compartment.

Special Provisions for Panel Modifications to Accommodate Line Side Taps

Exceptions for panel modifications to accommodate a line side tap for special (VNEM & SOMAH) applications can be requested and evaluated on a case by case basis. For example, customer's electrical service equipment commonly do not have sufficient space within the customers section to accommodate a Line Side Tap. If the scope of work for a Line Side Tap is to create (or enlarge an existing) customer section in the customer's electrical service equipment the following requirements must be met:

- An insulating red barrier separating the customer section and SCE section
- Two separate barriers separating the customer and SCE section
- Equipment must maintain any existing NEMA ratings
- Appropriate Placards must be installed labeling the sections
 - "SOLAR INTERCONNECTION TERMINATION SECTION"
 - "SCE UTILITY TERMINATION SECTION"

(5) General Requirements

5.4 Plot Plan Requirement

See [Appendix C](#) for a sample Plot Plan.

A plot plan must be provided to SCE for review for all projects that require an AC disconnect² (fused or non-fused). The plot plan should clearly show the locations of the AC disconnect switch(s) in relation to the SCE's utility meter. "Best" plot plans will include the following:

- SCE's utility meter and meter number
- AC disconnect switch
- Electrical service equipment
- Clearly show whether the SCE meter and AC disconnect switch are within line of sight of each other
- A scale and dimensions of spacing between the SCE meter & AC disconnect switch
- Naming convention of system components consistent with the SLD
- All other major electrical components related to the generating facility

Plot plans for larger or combined sites that show multiple interconnections should clearly indicate which area and equipment is dedicated to a specific POI.

5.5. AC Disconnect Requirements

In order for SCE to operate and maintain the Distribution System safely and reliably, it is mandatory that all electrical sources to SCE's Distribution System have the ability to be disconnected from the system with a single, visible open and lockable switching device.

NOTE: Customers should check with their local AHJ to verify if any specific local requirements apply. For safety reasons, SCE highly encourages customers to install an AC disconnect directly adjacent to their main service panel including installations in which it's not explicitly required by SCE.

5.5.1 Visible Open AC Disconnect Switch Requirements Voltages 34.5KV or below³

Per SCE requirements, a single visible open, lockable AC Disconnect is required for all of the following generating facilities:

- All Agricultural/Commercial/Industrial
- All Residential where Non Self-Contained Utility Meter is used
- All Line-Side Taps (additional overcurrent protection required); See [Section 5](#)
- All Generation Meter Adapters (additional overcurrent protection required); See [Section 8](#)
- All Net Generation Output Meters (additional overcurrent protection may be required); See [Section 7](#)

² See [Section 5](#) to identify which projects require an AC disconnect switch.

³ SCE's Interconnection Handbook provides the requirements for voltage greater than 34.5 kV.

(5) General Requirements

To safeguard anyone operating the medium voltage gear (Between 5 kV to 38 kV Class) from exposure to higher calories of energy, customers should install an AC Disconnect that includes one of the following:

- A viewing window to allow visible confirmation of the separation of disconnect blades without having to open the doors/panel.
- A full-length Arc Flash rated transparent barrier behind the door/panel so that when the door/panel is open it allows safe visual confirmation of the separation of disconnect blades
- A rackable breaker with appropriate barriers to shield exposed bussing instead of the AC Disconnect

5.5.2 Frequently asked questions on AC Disconnects:

1. What does single mean?

Single means that there's one AC disconnect that will isolate the customer's entire generating facility simultaneously by operating a single AC disconnect switch. It is to be understood that when there are multiple phases this is a ganged AC disconnect switch.

2. What does visible open mean?

Visible open means when the AC disconnect is in the open position, there is a visible separation between the contacts, and the separation may be observed without disassembling the device. AC disconnect switch contains an external lever, and a positive indication that the switch is in the off position

3. What does lockable mean?

Lockable means that the AC disconnect is capable of being locked in the open position (3/8" padlock).

Refer to [Rule 21](#) Section H.1.d and [SCE's Interconnection Handbook](#) for additional AC disconnect requirements.

5.5.3 AC Disconnect Type and Location Requirements

SCE engineers will review the type and location of the AC disconnect from the photos and plot plans provided by the interconnecting customers or site visits (when required). To clarify, the "Type" of AC disconnect, mentioned in this section is referring to scenarios in which additional overcurrent protection is required (whether the AC disconnect switch is required to contain fuses). All AC disconnects must meet the criteria stated in [Section 5](#) and the location requirements for these devices are as follows:

1. Line Side Connections: (See [Section 5](#) for additional information)

- a. For all line side connections, the location of the single, fusible, visible open, lockable AC Disconnect shall be directly adjacent to the PCC.

(5) General Requirements

- b. If the location of the fused AC Disconnect cannot be placed directly adjacent to the PCC then the assigned engineer will need to review and approve the location prior to installation; however, the placement of the overcurrent device shall be no further than 10 feet from the PCC. Refer to [Section 9](#) for a more detailed explanation of the Variance for AC Disconnect process and requirements.

2. Load Side Connections:

- a. For a load side connection, where the point of electrical connection is load side of the customer's main breaker, the single, visible open AC Disconnect shall be located near the PCC (Typically the meter, refer to [Section 10](#) for exact distance).
- b. If the location cannot be placed adjacent to the PCC, proper signage and accessibility will need to be reviewed and approved by the assigned engineer prior to installation of such device. Refer to [Section 9](#) for a more detailed explanation of the process and requirements.

3. Generation Meter Adapters (GMAs): (See [Section 8](#) for additional information)

- a. When a GMA is requested to be installed, the single, fusible, visible open, lockable AC Disconnect must be installed adjacent to the PCC.
- b. If the over-current protective device is in the AC Disconnect, then the AC Disconnect must be installed at a minimum of 2 feet to a maximum of 3 feet using liquid tight flex conduit.
- c. It is required that customers use 3/4 inch liquid tight bottom feed flex conduit with a 1 inch 90 degree connector to run the #6 AWG conductors wire (2 hot and a neutral, no green ground wire) from the GMA to the fused AC Disconnect..

Having the ability to disconnect and to secure the disconnection of the various electrical sources will allow SCE's workers to safely perform the required maintenance to the Distribution System by removing, tagging and taking the required clearances to the system where maintenance is to be performed. SCE's Distribution System is designed with switches and other devices that can be used to disconnect the SCE source to any section of the Distribution System. However, in order to achieve the required, complete isolation from all the sources, the generation facility sources that are connected to the Distribution System must also have the capability of being securely disconnected with a single, visible open and lockable switching device. SCE will accept the following alternatives to installation of a visible open and lockable disconnect in order to maintain the ability to disconnect the generating facilities from the Distribution System:

5.5.4 Self-Contained Meter⁴ with One Main Switch (Circuit Breaker, CB)

For these facilities, SCE can utilize the SCE revenue meter to disconnect the generation and load from the SCE Distribution System. See [Figure 2](#) for typical system configuration. In order to use this option, the following requirements must be met:

⁴ Reference SCE's Electrical Service Requirements for information on Self-Contained Meters.

(5) General Requirements

1. Facility must have a main breaker that can be operated by the customer on the same metering switchboard (meter panel) as the revenue meter.
2. Customer must agree that when it is necessary to disconnect the generating facility by opening the main CB and then removing the revenue meter, the customer will also experience an outage to the customer's facility until the meter is re-installed.

Restrictions:

For the facilities or the conditions below, the option of removing the revenue meter for disconnection purposes is not available. The customer must install a visible open disconnect adjacent to the PCC or at an approved location that should be in line of sight with approved signage and on a single disconnecting switching device as required by [Rule 21](#) and [SCE's Interconnection Handbook](#).

- a. Facilities that install a GMA
- b. Facilities that do not have a main CB in the metering enclosure.
- c. Facilities that are proposing to connect to the source side of the CB (when allowed).
- d. When customers do not agree on facility outage when required to disconnect the generator from the Distribution System.

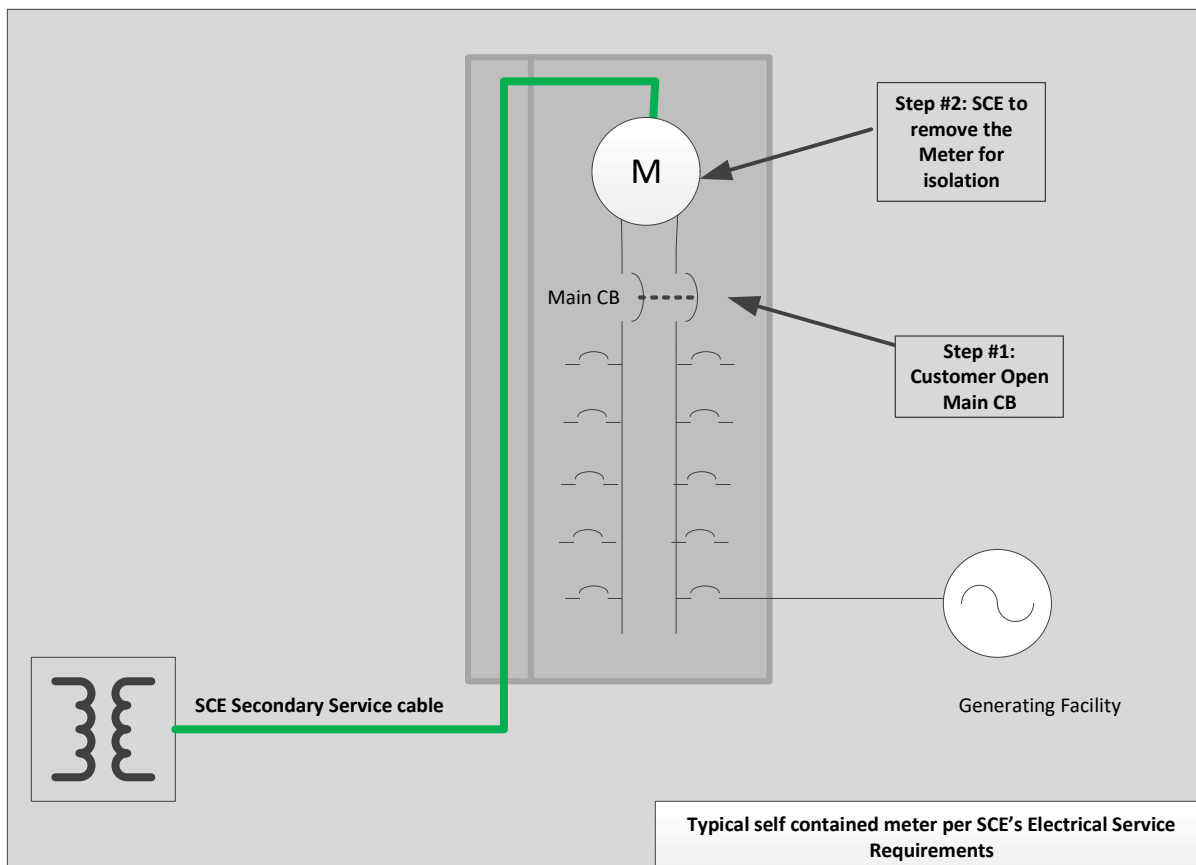

Figure 2- Typical Self-Contained Meter System

5.5.5 Non-Self-Contained Meter – Secondary Voltage Connection

These generating facilities cannot be disconnected by simply removing the revenue meter as the metering is achieved by current transformers (CTs). Refer to [Figure 2](#) for typical installation. These types of installations are typically utilized for medium-sized commercial or industrial customers. For these types of systems, the following are the disconnect device requirements:

3. Must comply with [Rule 21](#) Section H.1.d – Visible Open Disconnect Requirement and [SCE's Interconnection Handbook](#) Section 5.11.1- Manual disconnect.
4. One single disconnect is to be used to disconnect all generation at a facility.
 - a. When adding additional generation to a facility that currently has generation at the facility, the added generation must be connected to the existing disconnecting device.
5. The visible open disconnect must be adjacent to the Point of Common Coupling (PCC) **at an approved location that should be in the line of sight with approved signage and on a single disconnecting switching device as required by Rule 21 and SCE's Interconnection Handbook**, and must comply with access requirements per [Rule 21](#) Section H.1.d.
 - a. Inside the same electrical metering room.
 - b. Immediately outside the electrical metering room.
6. Location of visible open disconnect must be approved by SCE prior to installation.
 - a. Plot plan outlining the locations of the visible open disconnect must be provided in the interconnection request.
7. For all line-side connections, the Visible Open Disconnect must comply with [Section 5](#).

(5) General Requirements

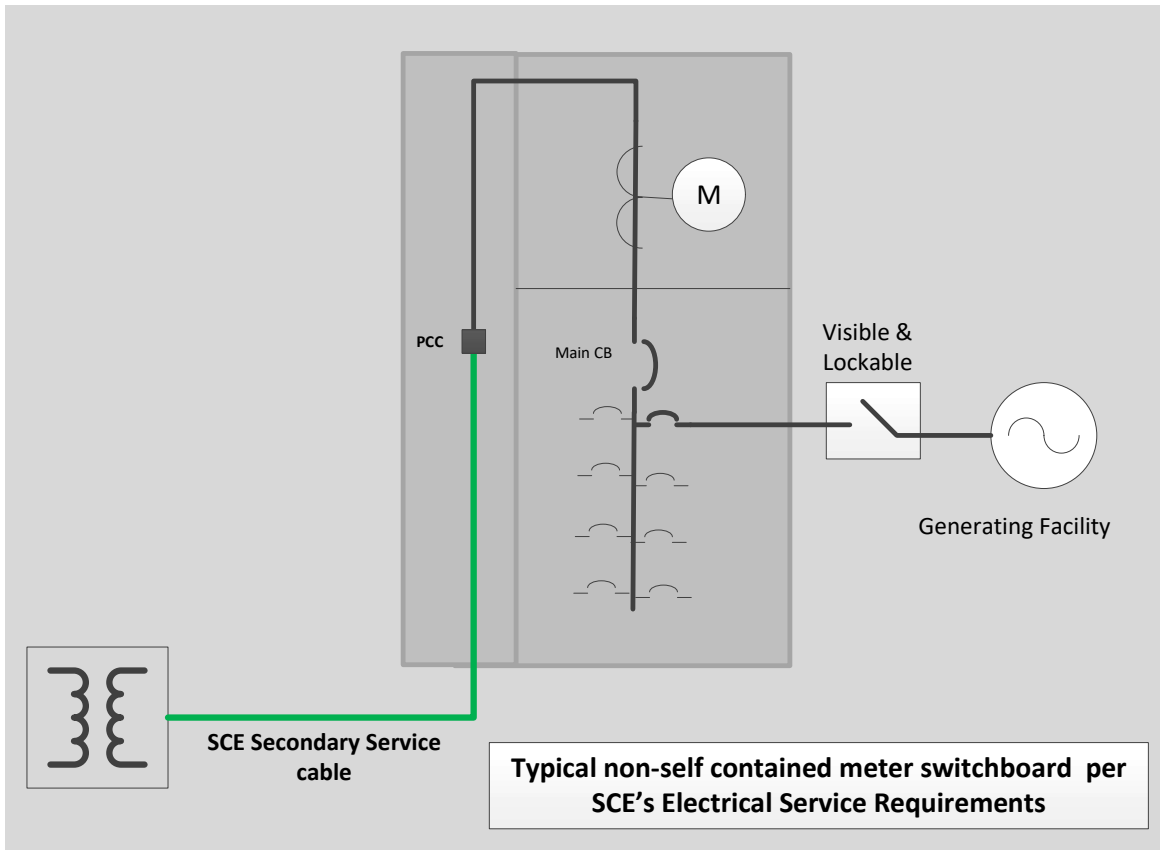

Figure 3 - Typical Non-Self-Contained Meter Switchgear

5.5.6 Primary Service Voltage Connections

These types of installations are typically utilized by large customers or by customers that have a campus-style electrical system. For these types of installations, the generation is typically installed on a panel fed by the customer's transformers (see [Figure 3](#)). For these types of installations, it becomes extremely difficult to comply with the "one single disconnect at the PCC" requirement. SCE's main intent is to have the ability to remove the generation from SCE's Distribution System so that SCE personnel may work on the Distribution System safely. To this extent, SCE and the customer can agree to use the customer's main rackable breaker to provide the disconnecting means when it is necessary to remove the generation from SCE's Distribution System. The following are the requirements:

1. Facility must have a main breaker that can be opened and racked-out by the customer.
 - a. SCE's clearance policies can take a clearance to a customer CB when SCE can take control over the CB. This would be accomplished by witnessing that the CB was racked out and by applying SCE's lock and tagging procedures.
2. Customer must agree, when necessary, to disconnect the generating facility by opening and racking-out the CB, the customer will also experience an outage to the customer's facility.

(5) General Requirements

- a. Customer must provide a letter on their company letterhead confirming agreement with this requirement.

Restrictions:

For the facilities or the conditions below, the option of using the main breaker for purposes of disconnecting the generating facility is not available; therefore, the customer must install a single visible open and lockable disconnect as required by [Rule 21](#) and [SCE's Interconnection Handbook](#) near the PCC and on a single disconnecting device.

- a) **Facilities that do not have a main CB that is capable of being racked-out.**
- Customer may replace the CB section with a rackable CB in order to meet the requirement.
- b) **When customer does not agree on facility outage when isolating the generator from the Distribution System.**

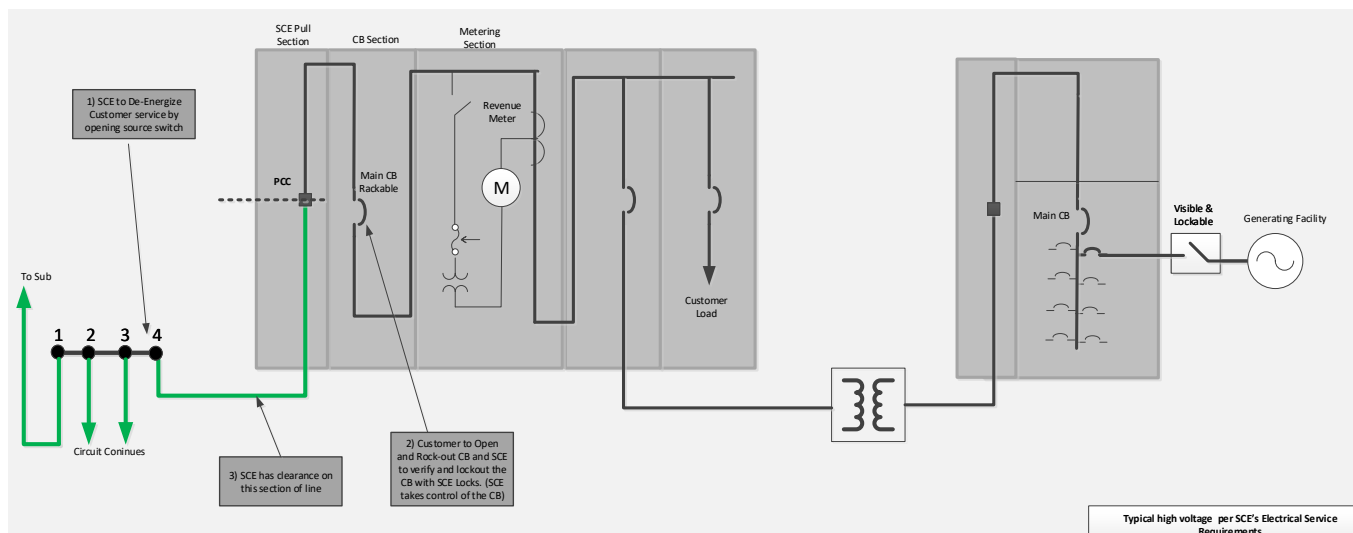

Figure 4 - Typical High-Voltage Service Interconnection

5.5.7 Circumstances when AC Disconnect May be Opened by SCE

The manual, visibly open, and lockable open AC Disconnect Switch or rackable circuit breaker would be operated by customer at SCE request under the following circumstances:

- Pre-emergency or planned work on the SCE system or metering equipment.
- A hazardous condition is revealed by an SCE inspection.
- To eliminate a condition that constitutes a potential hazard to SCE personnel or the general public.
- When protective device tampering is discovered.
- A generator-owner has failed to make available records of Verification tests and maintenance of its protective devices.
- A generator-owner's system interferes with SCE equipment or equipment belonging to other SCE customers.
- A generator owner's system is found to affect quality of service of adjoining customers.

(5) General Requirements

5.5.8 Remote Control Equipment

The installation of a Remote Control Equipment, as applicable for voltage, is required for any generating facility with a requested export greater than or equal to 1MW. The interconnecting customer is responsible for cost. Please see the SCE Unit Cost Guide for reference⁵ to equipment cost that is in accordance with Attachment A to Decision D16-06-052.

Remote Control Equipment can include the installation of a new switch, automation of an existing switch or recloser depending on voltage, location and space condition.

Remote Control Equipment installations utilizing a Load Drop Design configuration will be used to isolate the customer's entire facility if served by a single service delivery point as shown in **Figure 5**⁶ below.

NOTE: The Remote Control Equipment must be installed on the primary side of SCE's service transformer. The operation of the Remote Control Equipment isolates the customer's entire facility from the grid. The customer may elect to avoid this service interruption by installing a separate dedicated service upstream of the existing service. Please see the figures below for examples of these scenarios.

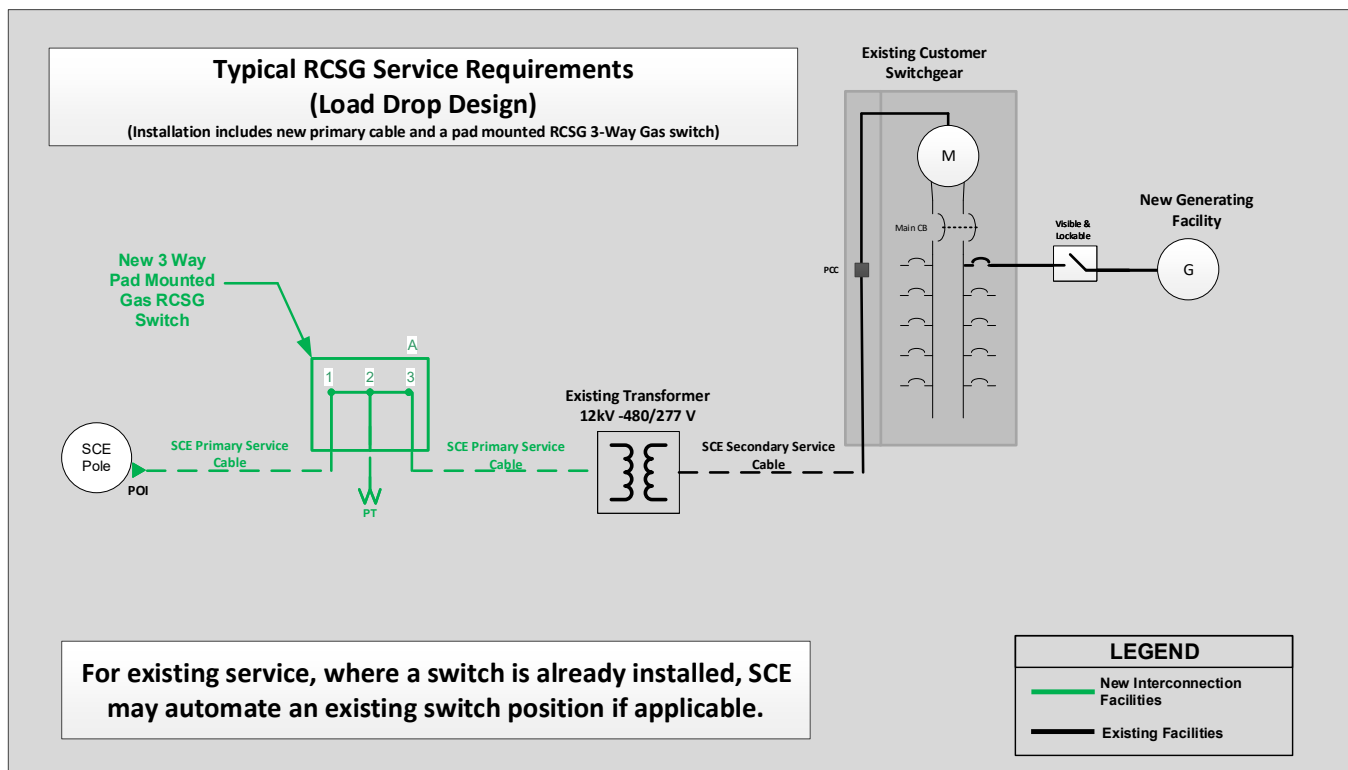

Figure 5 - Typical RCS-G Load Drop Design Requirements

⁵ Go to SCE's website (<https://www.sce.com/>) and search "Unit Cost Guide" to access the latest version.

⁶ Example shown in figure is for reference only. Other SCE design standards may be required based on customers' existing electrical service configuration.

(5) General Requirements

RCS-G installations utilizing a Non-Load Drop Design configuration will continue to serve the customer facility's loads while isolating the generation facility as shown in **Figure 6**⁷ below.

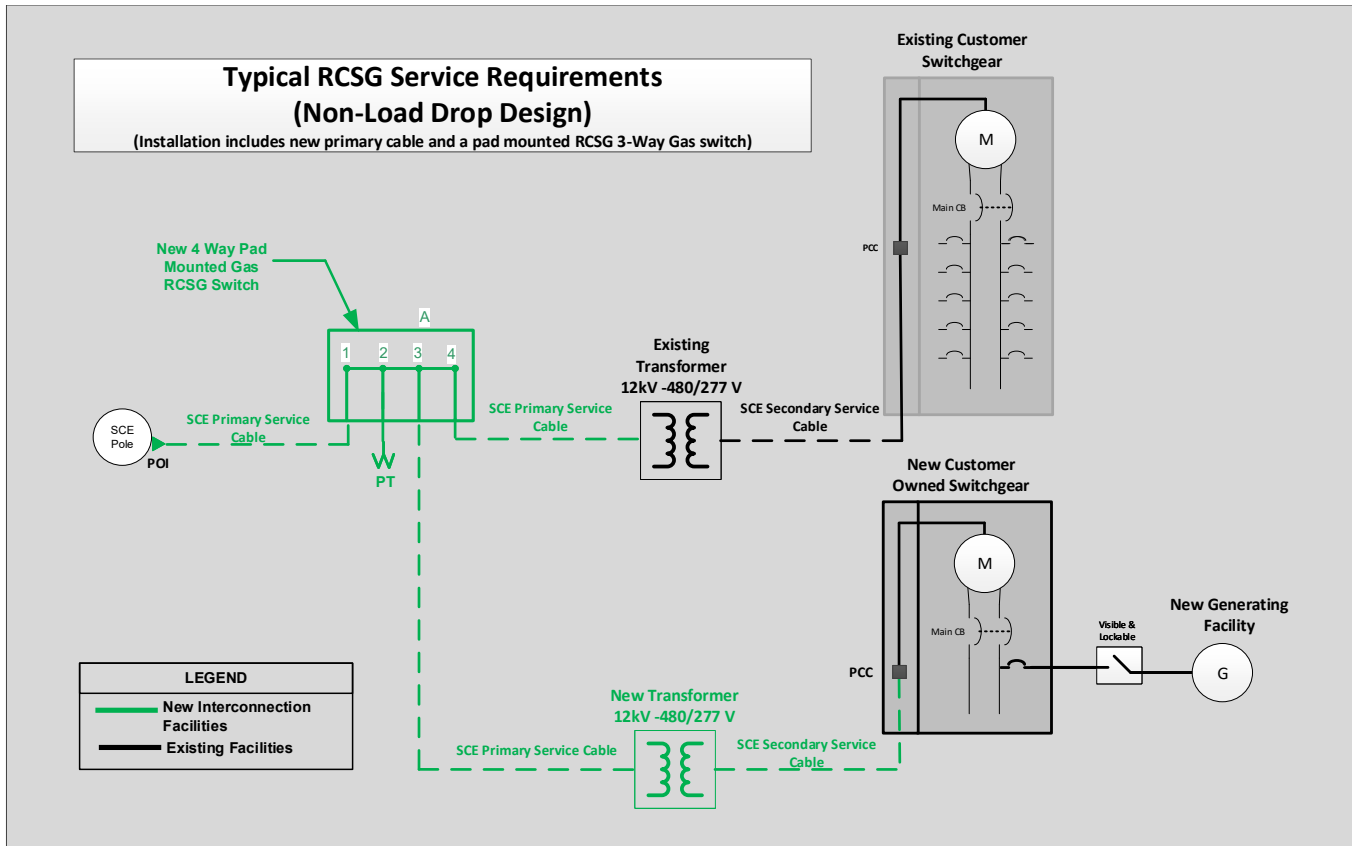

Figure 6 - Typical RCS-G Non-Load Drop Design Requirements

⁷ Example shown in figure is for reference only. Other SCE design standards may be required based on customers' existing electrical service configuration.

(6) PAIRED STORAGE REQUIREMENTS

6.1 Sizing Requirements for NEM Interconnection with Paired Energy Storage

Per the CPUC NEM-Paired Storage Decisions (D. 14-05-033 & D. 19-01-030), if the storage device (e.g., batteries, flywheels) is paired with an NEM eligible generator (e.g., solar, wind, etc.), and the storage device(s) has a total rating⁸ of 10 kW (AC) and below, there are no sizing restrictions or requirements for the storage device(s) (e.g., no requirement to be sized to the customer demand or the NEM generator). Paired storage systems of this size will be referred to herein as “NEM-Small Paired Storage Systems.”

For paired storage systems that have energy storage device(s) with a total rating larger than 10 kW (AC), the maximum output power of the storage device cannot be larger than 150% of the NEM Renewable Electrical Generating Facility’s (REGF) capacity. For example, if the REGF is sized to load at 20 kW, then the energy storage device(s) rating can be a maximum of 30 kW (AC). Paired storage systems of this size will be referred to herein as “NEM-Large Paired Storage Systems.” If a customer wishes to install a systems with a configuration ratio larger than 150%, they must apply with a multi tariff agreement and adhere to the associated [Rule 21](#) requirements. Per the CPUC Decision D.20-06-017, the maximum aggregate output capacity limitation shall not apply for a period of three years beginning August 16, 2020 and ending August 15, 2023 and the multi tariff agreement is not required during such period.

6.2 Options and Metering Requirements for NEM-Paired Storage Systems

For NEM-Small paired storage systems, no additional metering on either the NEM REGF or the storage device is required. Instead, an estimation methodology will be used in lieu of metering to validate the eligible NEM credits. However, a customer can opt-in to install a Non-Export Relay, Net Generation Output Meter (NGOM), or Certified Power Control System, when it is technically feasible to do so, instead of having the estimation methodology applied. In this case, the project must adhere to the metering requirements similar to those in the NEM-MT (multiple tariff) section of Schedule NEM.

For NEM-Large paired storage facilities, the project must adhere to the metering requirements similar to those in the NEM-MT section of Schedule NEM. These projects will be required to comply with one of the three (3) options below:

- Option 1. Install a Non-Export Relay⁹ on the storage device(s): [Section 6](#)
- Option 2. Install a NGOM directly to the NEM REGF(s): [Section 6](#)
- Option 3. Install a Certified Power Control System: [Section 6](#)
- Option 4. Utilize the Maximum Continuous Discharge rating methodology: [Section 6](#)

NOTE: Projects falling under this category must adhere to the NEM-MT metering provisions and are not eligible for the estimation methodology in lieu of metering.

⁸ Maximum Continuous Discharge Rate (kW) as defined by CEC Go Solar Website.

⁹ Please Reference Rule 21 Section G.1.i – Option 1 or Option 2.

(6) Paired Storage Requirements

6.3 Non-Export Relay for NEM-Large Paired Storage Systems

NEM-Large paired storage systems have the option to utilize a non-export relay to prevent export from the storage device(s) to the grid. In order to comply with NEM-MT non-export provisions NEM-Large paired storage relays may be configured with either of the following options:

- Option 1. "Reverse Power Protection"
- Option 2. "Minimum Power Protection"

Technical requirements for these non-export relay options are found in [Rule 21](#) Section G.1.i. When the customer elects to install a non-export relay, the relay settings must be provided to SCE for verification that they meet the requirements cited in [Rule 21](#). In addition to the relay settings, the customer must also provide a relay test report before a commissioning test may be scheduled and final PTO is given. Depending on design and configuration, the storage system may not be able to operate when any other eligible generator (REGF) is able to export. Figure 7 below is an example of how a non-export relay system could be configured for a NEM-Large paired storage system. Non-Export Relay for NEM-Large Paired Storage Systems

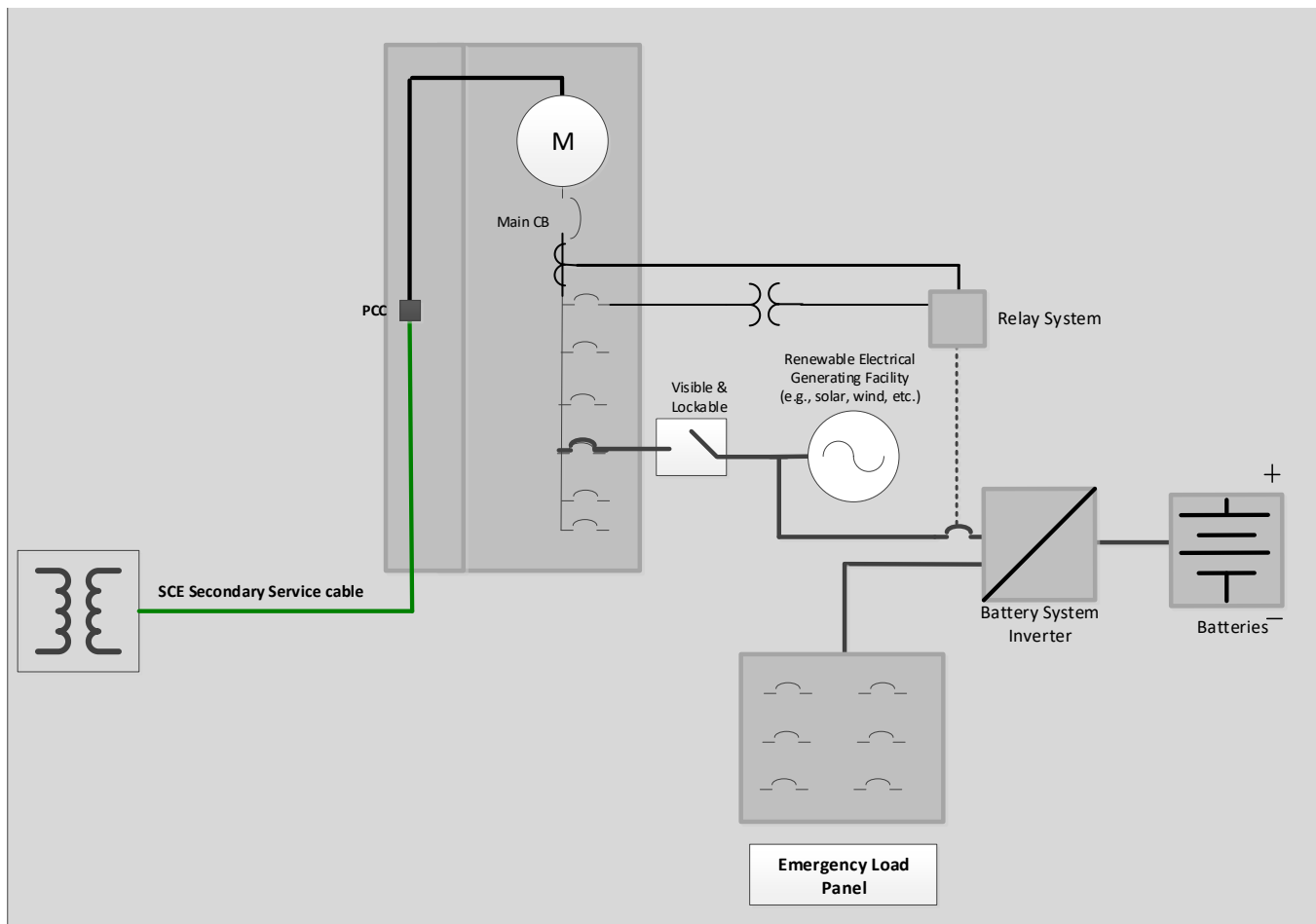

Figure 7 – Possible non-export relay configuration for NEM-Large Paired Storage System

(6) Paired Storage Requirements

6.4 Net Generation Output Meter (NGOM) for NEM-Large Paired Storage Systems

NEM-Large paired storage systems have the option to install a Net Generation Output Meter (NGOM) to measure the generation production of the customers' REGF. The combination of readings from the customers' main service meter and NGOM will be used to calculate the net energy usage/surplus of entire system. Please reference the AC Disconnect switch section requirements in this section below for additional requirements.

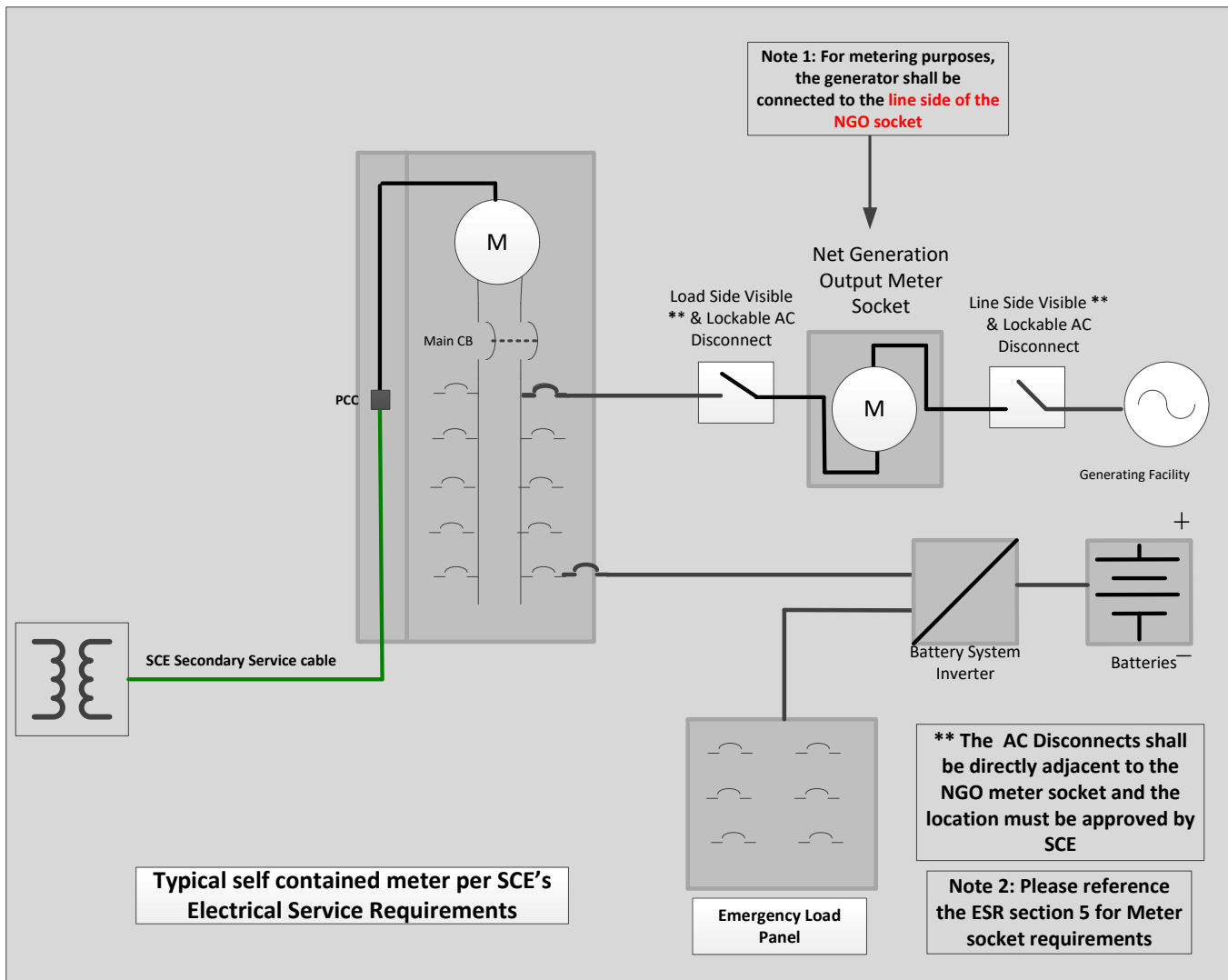

Figure 8 - NEM Paired Storage (AC) NGOM AC Disconnect Diagram

(6) Paired Storage Requirements

6.5 Certified Control Systems for NEM-Large Paired Storage Systems

NEM-Large paired storage systems have the option to utilize a Certified Power Control System to maintain NEM-ST integrity. There are three acceptable use case methods for applicability of the certified Power Control Systems to comply with NEM integrity:

- Use Case 1. Import Only Mode.** No Export to the Grid Operation - The energy storage device(s) are capable of charging from the grid (as well as the PV or REGF). However, are not allowed to export energy to the grid.
- Use Case 2. Export Only Mode.** No Charge from the Grid Operation - The energy storage device(s) are only capable of charging from the PV (or REGF). However, are allowed to export energy to the grid.
- Use Case 3. No Exchange Mode.** No Charge from the Grid and No Export to the Grid Operation. The energy storage device(s) are not capable of charging from the grid and are not allowed to export energy to the grid.

The maximum allowable open loop response time for NEM compliance must be equal or less than 10 seconds. The maximum open loop response time must be included in the certification documentation.

Certification of these Power Control Systems (PCS) must comply with the UL 1741-CRD Certification Requirements Decision (CRD) in addition to all current applicable certification requirements. Certification documentation must be provided to SCE for verification of UL CRD requirements. Controls options will be required to be witnessed and commissioned at the discretion of SCE engineering. SCE encourages that these systems be listed in the [California Energy Commission website](#) in order to expedite the review process.

The SCE verified UL-1741 SA PCS control list will be posted on [SCE NEM](#) site.

6.6 Maximum Continuous Discharge Sizing Option for NEM-Large Paired Storage Systems

This use case option adopts a means for measuring storage system size in direct current (DC) configurations in order to determine whether size restrictions and metering requirements apply. Therefore the utility can determine a storage system size as the lesser of the shared inverter's nameplate capacity or the storage device's maximum continuous discharge capacity listed on the storage device's technical specification sheets.

The datasheets for the storage device(s) and inverter(s) must be submitted and approved by SCE in order to validate the device(s) Maximum Continuous Discharge Rate¹⁰. If no data sheets are submitted for this option evaluation review SCE will evaluate and apply requirements based on the inverter nameplate rating.

See below example description and [Figure 9](#) for an example of the Maximum Continuous Discharge Sizing Option for NEM-Large paired storage systems.

¹⁰ Maximum Continuous Discharge Rate (kW) as defined by CEC Go Solar Website.

(6) Paired Storage Requirements

Example Description:

'Inverter A (7.5 kW)' and 'Inverter B (7.5 kW)' have a total nameplate rating of 15 kW, however each battery discharge rating has a verified total net of 5 kW maximum continuous discharge rate; therefore the system shall be evaluated at the gross total 10 kW maximum continuous discharge rate and therefore also be considered a Small-NEM Paired Storage System. This results in only requiring that the estimating methodology be used in lieu of the NGOM meter requirement or Non-Export Relay.

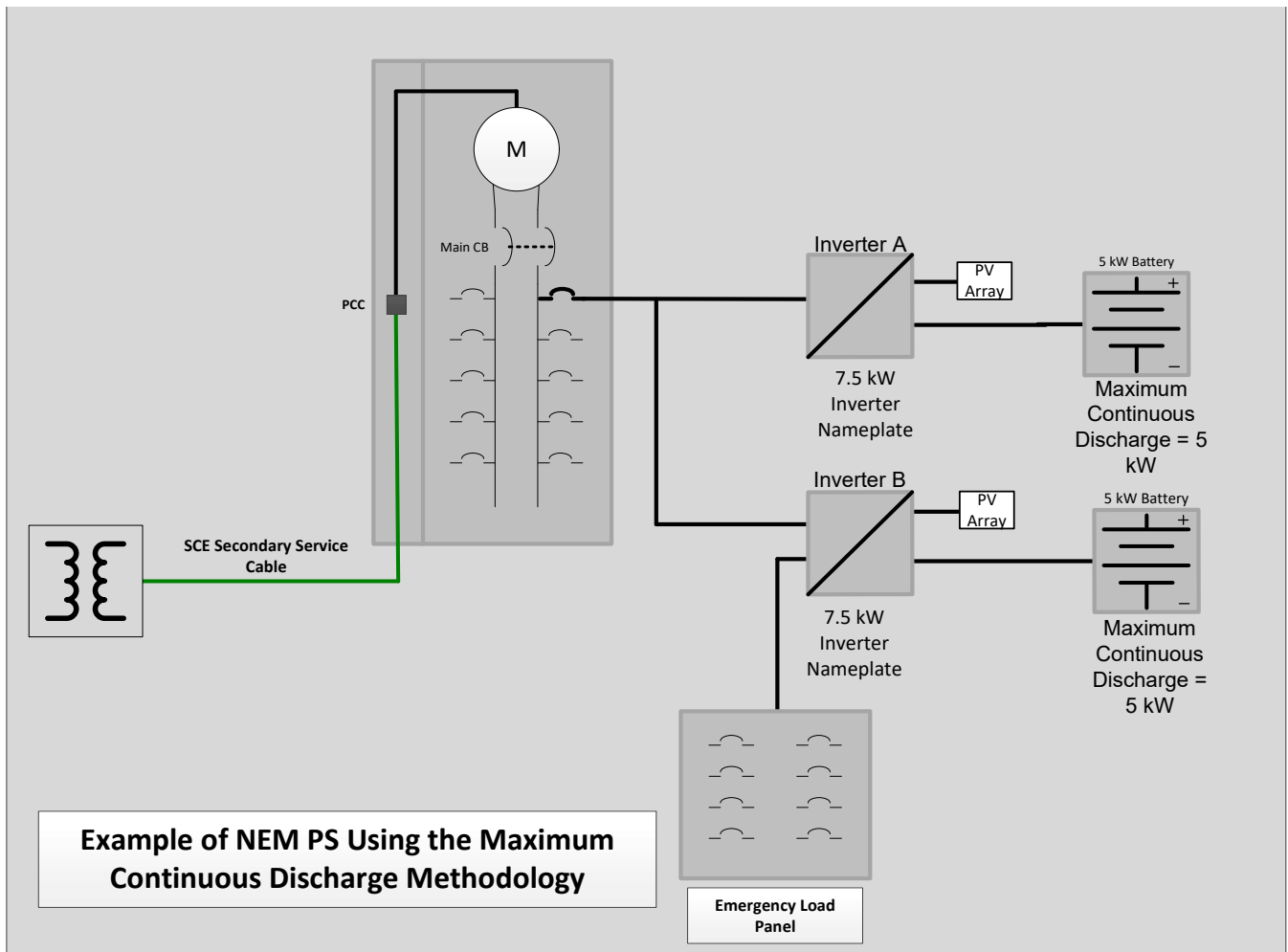

Figure 9 – Example of Maximum Continuous Discharge Methodology

(7) NET GENERATION OUTPUT METER (NGOM)

A Net Generation Output Meter (NGOM) is an additional meter (in addition to the customer's main service meter) to measure the output of the customer's REFG. A NGOM may be required as indicated in the applicable NEM [Rate Schedule](#) – see [Section 1](#) for a list of Rate Schedules.

NEM-Large paired storage projects where the customer elects to install a NGOM (see [Section 6](#)) and Virtual Net Energy Metering (VNEM) type projects (schedules [NEM-V-ST](#) and [SOMAH-VNM-ST](#)) require a NGOM to be paid for by the customer to meter the REGF.

7.1 General Requirements for NGOM's

Requirements for NGOM installations may vary depending on the tariff type as well as the method of interconnection. The general requirements listed in this section are specific to NGOM installations and are supplemental to those of [Section 5](#).

Documentation Requirements for NGOM's

For NGOM installations the following documentation must be provided to SCE:

- **Single Line Diagram:** See [Section 5](#) & [Section 7](#) for requirements.
- **Plot Plan:** See [Section 5](#) & [Section 7](#) for requirements.
- **Photos of AC Disconnects:** See [Section 5](#) & [Section 7](#) for requirements.
- **NGOM Panel Specifications & Data Sheet:** Must specify a EUSERC #
- **Customer Project Information Sheet (CPIS):**
- **Signed Final Inspection:** May be provided after NGOM installation is complete.

If the scope of the project includes a line side tap, please refer to [Section 5](#) for a comprehensive list of requirements, however for NGOM installations in which the point of interconnection is a line side tap the following supplementary documentation must be provided to SCE:

- **Signed Line Side Tap Letter:** Please refer to [Appendix F](#) (May be provided after NGOM installation is complete.)
- **Photos of the requested POI:** This should include close up and far away views of the service equipment and include a detailed scope of work to accommodate the POI. Please refer to [Section 5](#) for additional information.

Please refer to [Figure 9](#) for a simplified NGOM Installation Process Flow.

NOTE: Exceptions for panel modifications to accommodate a line side tap for VNEM type projects may be granted at SCE's discretion. This is highly dependent upon the existing service equipment and the scope of work. Please refer to [Section 5](#) for additional information on these requests.

(7) Net Generation Output Meter (NGOM)

NGOM Installation Process Flow

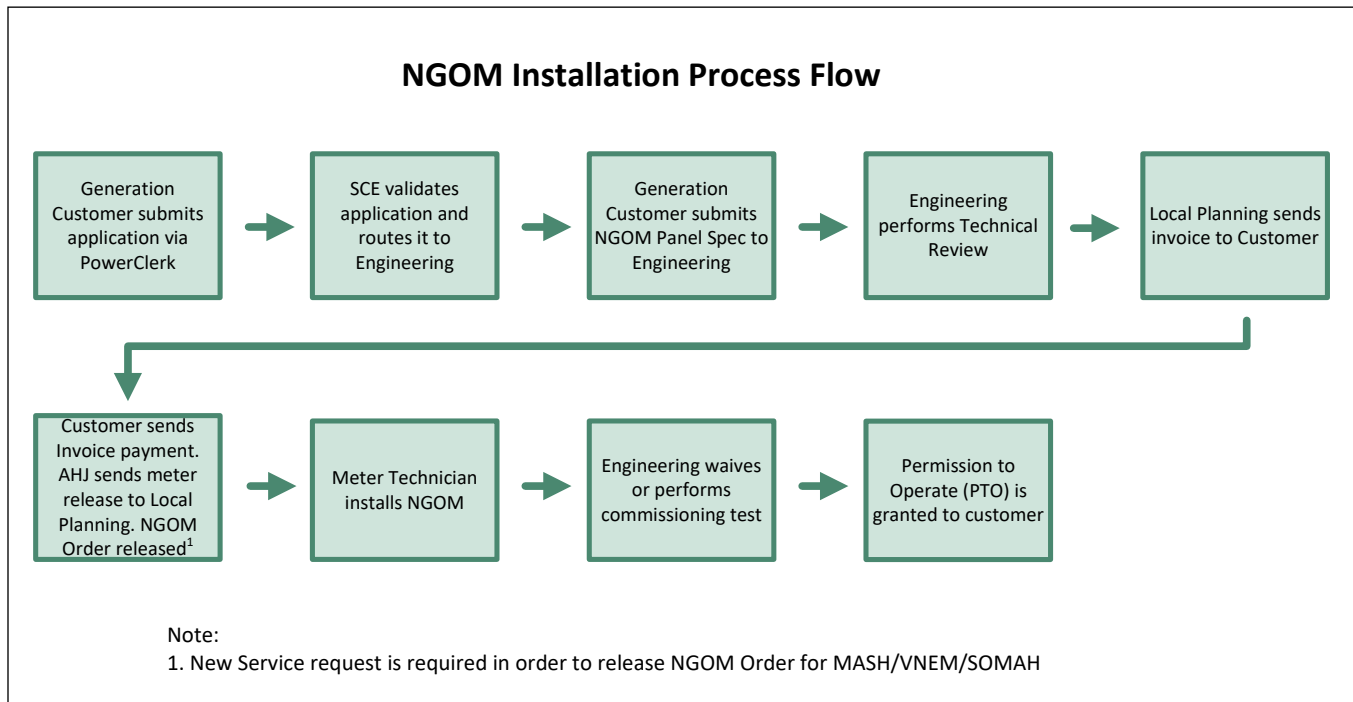

Figure 10 – NGOM Installation Process Flow

7.2 Technical Requirements for NGOM's

Technical requirements for NGOM installations may vary depending upon the tariff type, method of interconnection, and service voltage. Please refer to [Section 7](#), for SLD, Plot Plan, and AC disconnect requirements respectively for information specific to NGOM installations. The technical requirements listed in these sections are specific to NGOM installations and are supplemental to all other requirements listed in this handbook, SCE's [ESR](#), and SCE's [Rule 21](#).

The customer is responsible for the procurement and installation of the NGOM socket per SCE's [ESR](#). Please refer to [Appendix G](#) for the NGOM Panel EUSERC Drawing Number Guide Table to select a compatible NGOM panel. Refer to [ESR-1](#) Section 12 and [Figure 6](#) for additional wiring instructions of the NGO socket.

(7) Net Generation Output Meter (NGOM)

7.2.1 Single Line Diagram Requirements for NGOM's

The SLD requirements listed below are specific to NGOM installations and are in addition to all requirements listed in [Section 5](#) and [Appendix A](#) of this handbook:

- Callout pointing to NGOM "Request for NGOM Installed by SCE", including service configuration (i.e. 200A, 3ph, 4W, 480/277V)
- Visible, lockable open, AC disconnects connected on both sides of the NGOM as per [figure 6](#)

For VNEM type projects the NGOM and generating facility must not be interconnected behind any SCE meter. These interconnections commonly utilize existing SCE service panels/meter banks to interconnect the generating facility to the grid. In this scenario please provide the following on the SLD:

- SCE main house meter number for reference

If the scope of work for the project includes a line side tap, please include the following on the SLD:

- Signed PE Stamp
- Fused AC Disconnect directly adjacent to (or within 10 feet of) the POI
- Line of delineation between SCE's section and the Customers' section
- Callout indicating "Line Side Tap"

7.2.2 Plot Plan Requirements for NGOM's

The Plot Plan requirements listed below are specific to NGOM installations and are in addition to all requirements listed in [Section 5](#) and [Appendix B](#) of this handbook:

- Clearly show the distance from the SCE meter to the Fused AC disconnect switch
- Show the NGOM panel location and associated AC disconnect switches

7.2.3 AC Disconnect Requirements for NGOM's

When a NGOM meter socket is installed, a line side and a load side ganged operated, visible open, lockable AC Disconnect shall be installed. See [Figure 10](#). * Note, Interconnection facilities must also comply with SCE Electrical Service Requirement (ESR-1, Section 12 Customer Generators).

- For NGO meter sockets rated at greater than 600 V, the visible, lockable, AC Disconnects shall be installed directly adjacent to the NGO meter socket.
- For NGO meter sockets rated at 600 V or below, should be installed directly adjacent to the NGO meter socket but can be installed in line of sight of the NGO meter socket when locating adjacent to the NGO meter in not physically possible.
- These visible, lockable, AC Disconnects may be in addition to the single AC Disconnect that is required to isolate the entire generating facility.

(7) Net Generation Output Meter (NGOM)

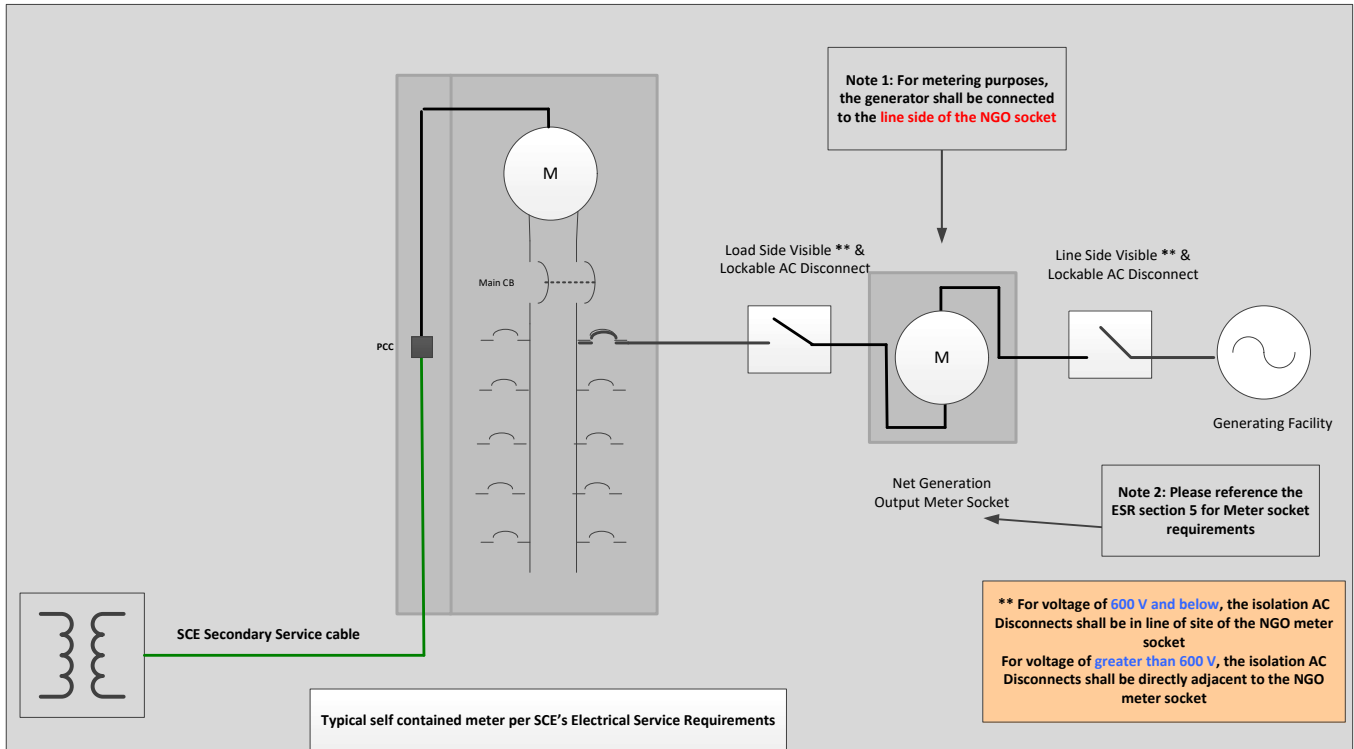

Figure 11 - Typical Self-Contained Meter System with NGO Metering and AC Disconnects

(7) Net Generation Output Meter (NGOM)

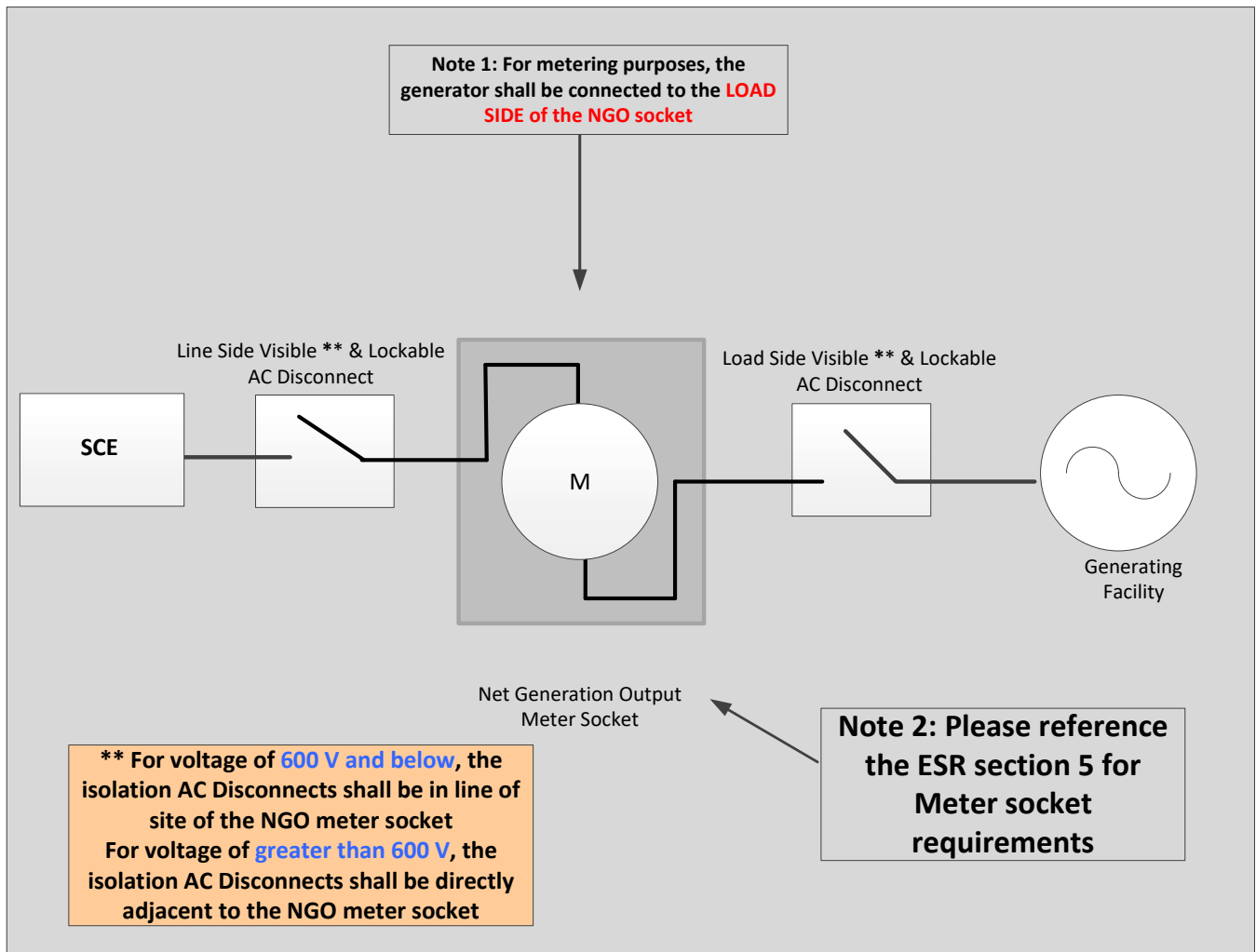

Figure 12 - Wiring of a Typical NGO Meter Socket. For Virtual Net Metering Projects. Please reference ESR-5 Section 6 for acceptable meter locations

7.2.4 Virtual NEM NGOM Installation

For VNEM type projects, the NGOM Meter must be installed parallel to other SCE revenue meters. It is prohibited to install NGOM meters on the SCE sealed sections. In order to install a VNEM NGOM it may require a line side tap connection, it is strongly advised to consult with your design engineer and submit a design proposal to SCE for getting clearance on the tap connection. Please refer to [Section 5](#) for a comprehensive list of requirements for projects that include a line side tap.

(7) Net Generation Output Meter (NGOM)

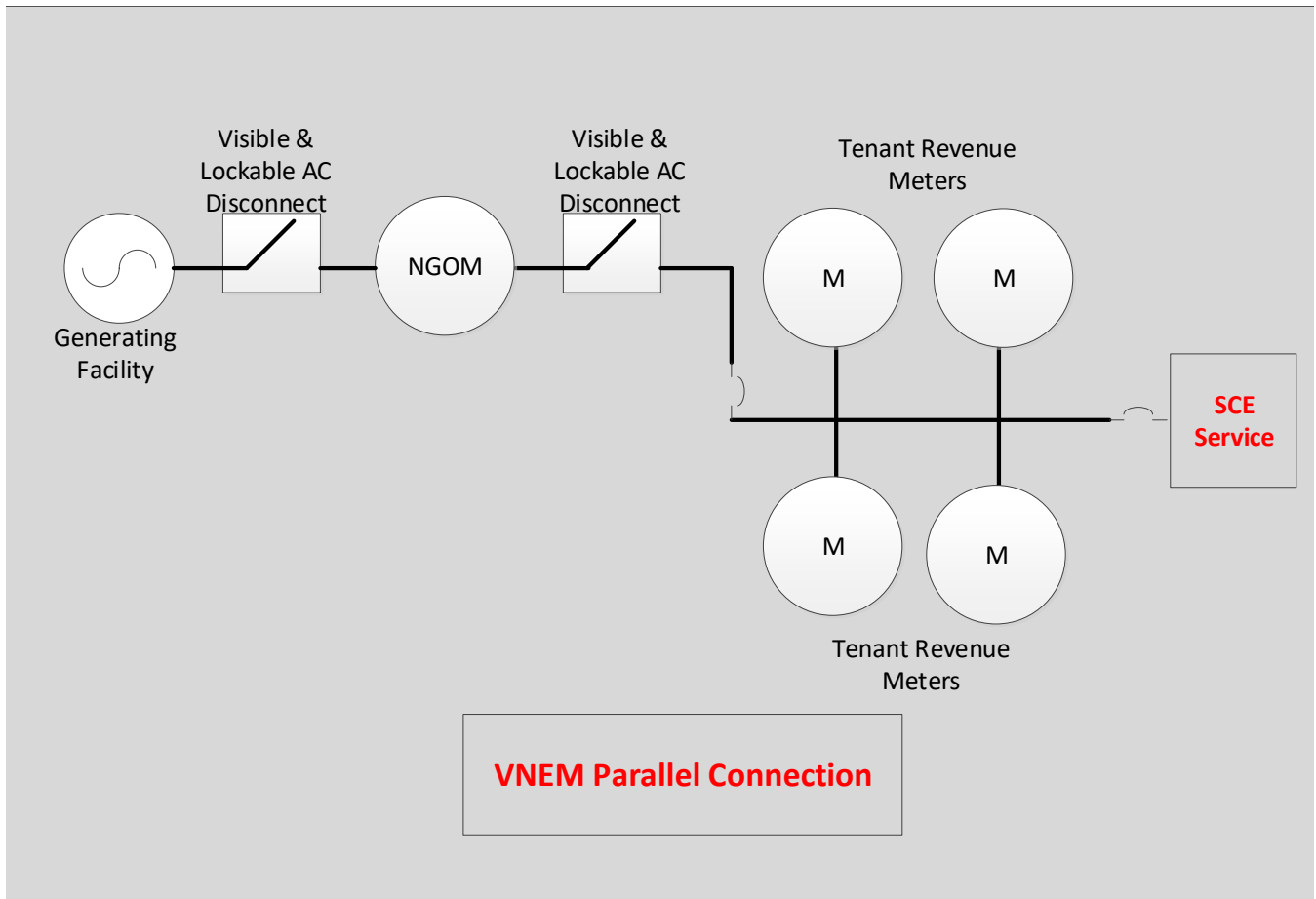

Figure 13 – Example of VNEM Parallel Connection

(8) GENERATION METER ADAPTER (GMA)

A Generation Meter Adapter (GMA) is an approved method to interconnect your residential NEM project to SCE's electrical grid. The GMA will be installed between the residential customer's electrical service panel socket and the SCE revenue meter and will be used to facilitate an alternative interconnection option to the traditional supply side connection without the need to modify the service panel.

SCE will own and install the GMA at the customer's expense pursuant to the terms and conditions of an Interconnection Facilities Financing and Ownership Agreement (IFFOA).

SCE will install and own the following GMA meter socket:

- Socket Meter Extender Cat. #: EZ 1000-0-R-Solar
- Manufacturer: Marwell Corporation customer's service panel.
- Please Refer to Marwell Corporation (Part # EZ 1000-0-R-Solar) for UL Listed Meter Socket Adapter Specification Sheet

8.1 General Requirements for GMA's

Customers can request to utilize a GMA when applying for a NEM interconnection. Simply select "Line Side-Generation Meter Adapter" as a method of interconnection on the online application. Please refer to the GMA fact sheet on www.sce.com/nem for additional information and FAQs. The general requirements listed in this section are specific to GMA installations and are supplemental to those of [Section 5](#).

GMA's are only to be used for Solar NEM projects that do NOT include storage, DC coupled inverter systems, Paired Storage Systems or additional residential load between the generator and the GMA (a backed up/emergency loads panel). Additionally, a maximum inverter nameplate capacity of the GMA shall be 65 amps (15.6 kW @ 240V), and a maximum fuse of 65 Amps or less must be installed. Additionally, it is required that customers use 3/4 inch liquid tight bottom feed flex conduit with a 1 inch 90 degree connector to run the #6 AWG conductor wire (2 hot and a neutral, no green ground wire) from the GMA to the fused AC Disconnect.

Note: Paired storage systems are permitted to interconnect in parallel utilizing a load side connection method of interconnection. All solar Generation must be behind GMA.

Reference: [Generation Meter Adapter for Net Energy Metering - Interconnection](#)

(8) Generation Meter Adapter (GMA)

8.1.1 Documentation Requirements for GMA's

When a customer elects to install a GMA the following documentation must be provided to SCE:

- **Single Line Diagram:** See [Section 7](#) for requirements.
- **Plot Plan:** See [Section 7](#) for requirements.
- **Customer Project Information Sheet (CPIS):**
- **Signed Final Inspection:** May be provided after GMA installation is complete

Note: Photos of the fused AC disconnect are not required to be uploaded for review because the equipment will be verified by SCE upon installation of the GMA.

GMA Installation Process Flow

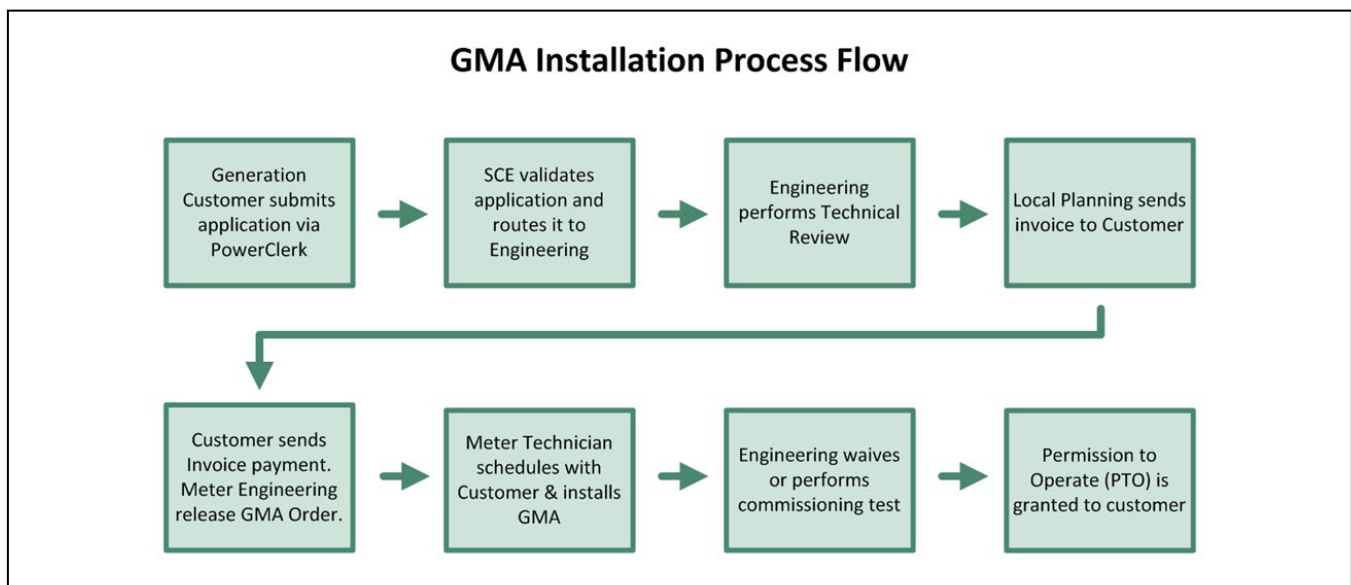

Figure 14 – GMA Installation Process Flow

8.1.2 Eligible Service Panels for GMA Installations

- Must be residential, single phase 120 or 120/240 V service
- Must be rated at 200 amps and below
- Must be installed on a service panel manufactured with an existing main breaker
- Must have the ability for the neutral conductor to be terminated in the customer's breaker section

Note: Residential Mobile Home Parks with single pedestal panels and Single Family Homes with single pedestal panels will be reviewed for GMA installation approval on a case by case basis and must meet requirements mentioned in [Section 8](#) & Section 8 General Requirements for the GMA.

(8) Generation Meter Adapter (GMA)

8.1.3 Ineligible Service Panels for GMA Installations

- Service panels with existing meter adapters
- Service panels with existing ESR violations
- A-Base adapter meter sockets or remoter meter panels
- Main breaker in a different location to where the SCE revenue meter is located
- Current transformer rated panels
- Residential or commercial three phase service
- Multi-metered service panels
- Old sequence service panels
- Panels that cannot have a neutral conductor terminated on customer's section

8.2 Technical Requirements for GMA's

SCE considers the use of the GMA as an alternative to a conventional line side connection to the customer's service panel. Before applying for a GMA installation verify the service panel is compatible based on the Eligible Service Panels for GMA Installations and Ineligible Service Panels for GMA Installations specifications in [Section 8](#) respectively. Please refer to [Section 8](#) for SLD, Plot Plan, and AC disconnect requirements respectively for information specific to GMA installations. The technical requirements listed in these sections are specific to GMA installations and are supplemental to all other requirements listed in this handbook.

NOTE: A maximum inverter nameplate capacity of 65 amps (15.6 kW @ 240V) is eligible to be installed downstream of a GMA. Paired storage or load are NOT eligible to be installed downstream of a GMA.

8.2.1 Single Line Diagram Requirements for GMA's

The SLD requirements listed below are specific to GMA installations and are in addition to all requirements listed in [Section 5](#) and [Appendix B](#) of this handbook:

- Callout pointing to SCE Meter "Request for Generation Meter Adapter Installed by SCE"
- Main service panel Ampacity rating
- Main circuit breaker rating
- Fused AC disconnect switch and fuse size (Please note a maximum fuse of 65 Amps or less must be installed)
- Callout pointing to the Fused AC disconnect switch "Fused AC disconnect switch be located between a minimum of 2 feet and a maximum of 3 feet from the SCE Meter"

(8) Generation Meter Adapter (GMA)

8.2.2 Plot Plan Requirements for GMA's

The Plot Plan requirements listed below are specific to GMA installations and are in addition to all requirements listed in [Section 5](#) and [Appendix C](#) of this handbook:

- Callout pointing to SCE Meter "Request for Generation Meter Adapter Installed by SCE"
- Clearly show the distance from the SCE meter to the Fused AC disconnect switch

8.2.3 AC Disconnect Requirements for GMA's

When a customer elects to use a GMA, a single, fusible, visible open, lockable AC Disconnect shall be installed adjacent to the PCC. The fused AC Disconnect must be located a minimum distance of 2 feet and a maximum of 3 feet from the SCE revenue meter. This provides SCE crews adequate space to work on the residential service panel if necessary. Additionally, it is required that customers use 3/4 inch liquid tight bottom feed flex conduit with a 1 inch 90 degree connector to run the #6 AWG conductor wire (2 hot and a neutral, no green ground wire) from the GMA to the fused AC Disconnect.

NOTE: GMA installations will be permitted by SCE with overcurrent protection (other than a fused AC disconnect) located within 2 - 3 feet from the SCE meter under the condition that a single, visible open, lockable AC disconnect shall be installed directly adjacent to or within 10 feet of the PCC.

(8) Generation Meter Adapter (GMA)

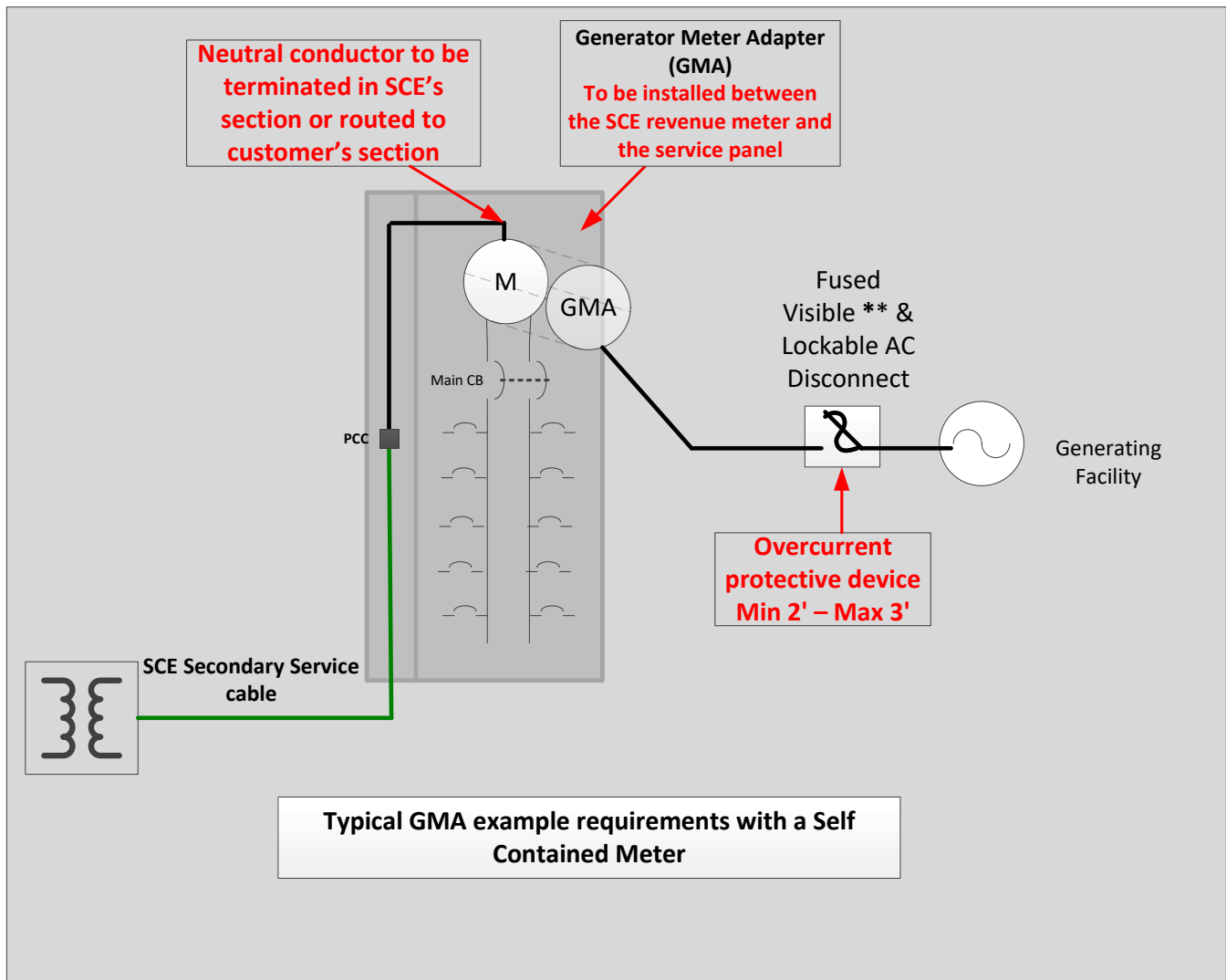

Figure 15 - Typical GMA example requirements

8.2.4 Grounding Customer Systems Downstream of GMA

Proper grounding on the customer panel and AC disconnect is the customer's responsibility. The customer is responsible for properly grounding their equipment according to the AHJ requirements without relying on SCE owned equipment.

- The GMA is SCE equipment and becomes part of the meter when installed
- No customer owned conductors, including grounding conductors, are allowed in the GMA or its attached conduit
- If customer wishes to tie their generation system ground to their service panel ground they may install a second conduit to the breaker section of their service panel

(9) PROTECTION REQUIREMENTS

9.1 Protection Requirements

The interconnection of a new NEM generating facility to the SCE Distribution System must not degrade any of the existing SCE protection and control schemes nor lower the existing levels of safety and reliability for other customers.

Generating Facilities operating in parallel with SCE's Distribution System shall be equipped with the following Protective Functions to sense abnormal conditions on SCE's Distribution System and cause the Generating Facility to be automatically disconnected from SCE's Distribution System or to prevent the Generating Facility from being connected to SCE's Distribution System inappropriately:

- Over and under voltage trip functions and over and under frequency trip functions.
- A voltage and frequency sensing and time-delay function to prevent the Generating Facility from energizing a de-energized Distribution System circuit and to prevent the Generating Facility from reconnecting with SCE's Distribution System unless SCE's Distribution System service voltage and frequency are within normal operating limits and are stable for at least 15 seconds.
- A function to prevent the Generating Facility from contributing to the formation of an Unintended Island, and cease to energize SCE's Distribution System within two seconds of the formation of an Unintended Island (Island; Islanding: A condition on SCE's Distribution System in which one or more Generating Facilities deliver power to customers using a portion of SCE's Distribution System that is electrically isolated from the remainder of SCE's Distribution System.)
- The Generating Facility shall cease to energize SCE's Distribution System for faults on SCE's Distribution System circuit to which it is connected (IEEE 1547-4.2.1). The Generating Facility shall cease to energize SCE's Distribution circuit prior to re-closure by SCE's Distribution System equipment (IEEE 1547-4.2.2).

Please reference [SCE's Interconnection Handbook](#) for complete set of technical requirements.

The customer's system-protection facilities are at the customer's expense, and must be installed, operated, and maintained in accordance with all the applicable regulatory requirements and in accordance with the design and application requirements of this Handbook.

(9) Protection Requirements

9.2 Inverter Protection Settings

All inverter protection settings must comply with [Rule 21](#) Section Hh. The customer can set relays or settings more stringent than required by [Rule 21](#) upon approval by SCE.

Conditions for voltage and frequency settings per SCE's [Rule 21](#) below:

- If the inverter is 30 kW or below, protection settings are approved if the inverter is UL listed (all CEC approved inverters meet this guideline)
- If inverter is larger than 30 kW, protection settings can be field adjustable therefore it may be required that:
 - Site verification that it is UL listed
 - Inverter settings letter on each inverter would have to be submitted to SCE.

If settings cannot be verified during a commissioning test, the customer can obtain a letter from the inverter manufacturer providing the inverter settings and their respective serial number. Distribution Engineering will verify the proposed settings to ensure that they meet [Rule 21](#), Section Hh requirements -- see [Appendix D](#).

9.3 Ground-Fault-Sensing and Stabilization

When required by [SCE's Interconnection Handbook](#) (PDF), a ground-fault-sensing scheme that detects SCE's ground faults and trips the generator breaker or the generator's main circuit breaker, preventing the generator from continuously contributing to the ground fault may be required.

The ground-fault-sensing scheme will consist of either a ground detector or ground bank depending on the configuration of SCE's Distribution System. The customer is responsible for the additional cost associated with the installation of the ground detection scheme.

9.4 Secondary Network Interconnection

Interconnection of NEM facilities onto SCE's secondary network Distribution System will require a supplemental review. However, due to the complexity of secondary networks, additional requirements must be met to ensure continued reliable operation of the network. In addition to standard NEM requirements, NEM interconnections must use one of the following to ensure non-export to the SCE secondary network:

- (Preferred) An under-power relay (minimum-import relay) should be installed to monitor power flow at the PCC. The relay should be set to disconnect the NEM generator from the SCE system when input power at the PCC falls below [Rule 21, G.1.i](#). Requirements (5% of the Generating Facility's total Gross Nameplate Rating, with a maximum 2.0 second delay).

(9) Protection Requirements

- A reverse power relay should be installed to monitor power flow at the PCC. The relay should be set to disconnect the NEM generator from the SCE system when reverse power flow at the PCC exceeds the requirements outlined in [Rule 21, G.1.i](#). (0.1% of the service transformer's rating, with a maximum 2.0 second delay).

9.5 Telemetry

NEM projects with an aggregate system size 1MVA nameplate or larger will require telemetry equipment and telecommunications at Producer's expense. For AC coupled NEM-paired storage systems, the nameplate of the battery storage inverter is included in calculating the aggregate system size. Please refer to Section 7 of [SCE's Interconnection Handbook](#) for information about telemetry requirements.

(10) ADDITIONAL REQUIREMENTS

10.1 Plug-In Generation Facilities to Electrical Wall Outlet

Plug-In generation facility projects are projects that have the ability to interconnect onto the customer's facility electrical system through an electrical outlet. SCE does not approve the use of these types of plug and play generation facilities proposing to interconnect and operate in parallel with SCE's Distribution Grid. These types of interconnections pose a safety and reliability concern to the public and SCE employees due to the ability of the end user to move the plug and play generator to any electrical outlet, thereby, violating NEC code 705.12(D) (1).

10.2 Variance for AC Disconnects

For NEM projects that are unable to meet the requirements specified in this handbook when installing an AC disconnect switch due to clearance, access, or safety reasons, a variance request may be submitted by the interconnecting customer. The variance request can be submitted along with the Interconnection Request (IR) or it can be processed as part of the interconnection deficiency response process. Variance requests must be submitted for the following three reasons:

1. Unable to isolate the entire Generating Facility behind a single AC disconnect as specified in [Section 5](#).
2. Unable to locate the AC disconnect as specified in [Section 5](#) (directly adjacent to or within line of sight of the PCC).
3. Any distances, from the AC disconnect to the PCC, greater than 50' will need to be specifically reviewed by SCE for approval.

NOTE: AC Disconnect Variance will not be permitted for GMA installations.

All variance requests will be evaluated by SCE on a case by case basis. All requirements must be satisfied and accepted in order to meet safety requirements set forth and obtain PTO from SCE. These requirements do not excuse the interconnecting customer from following all applicable CEC, local AHJ, or any other requirements set forth in Rule 21 and this NEM Handbook. Please contact SCE for questions related to a variance request for AC disconnects.

(10) Miscellaneous Requirements

10.3 Unique address for New meter electrical service panel and Net Generation Output Metering (NGOM) panel(s)

- The new address must be unique (not already in use), match the permit address provided by the Authority Having Jurisdiction (AHJ)* and ultimately, match the address to be requested for service with SCE.
- The unique service panel address in the AHJ permit must also match the address entered in the Customer Project Information Sheet (CPIS), if applicable. If the address does not match, the project will not be approved.
- Before submitting the construction permit application, check with the AHJ on how to specify the unique address in the permit so it matches their assigned address.
- SCE's Local Planning Department uses the address in the approved service panel permit that is sent directly by the AHJ to validate the address in the meter service order before releasing it for installation.
 - The meter service order address is created using the CPIS form submitted with the interconnection request.

10.4 Meter Spot Request Process

- Prior to requesting a meter spot, ensure you have a signed contract and your customer has been notified that a meter spot has been requested on their behalf. Your customer should be aware that SCE personnel will need to make a site visit.
- When requesting for a meter spot, keep the following in mind:
 - Call SCE's Service Planning department prior to installing a meter panel for the Net Generation Output Meter (NGOM)
 - Ensure compliance with the Electrical Service Requirements (ESR) Manual
 - Special attention should be focused on ESR-5 Section 6, which describes the prohibited meter locations.
 - NOTE: No equipment can be installed in SCE's pull section or any SCE sealed sections of the service panel.
 - Obtain approval from SCE's local Planner to preclude the possibility of having to relocate a panel after it has been installed (the contractor/customer would incur additional costs).

NOTE: When a meter panel installation does not comply with SCE's ESR, any employee can refuse to work on equipment that might be consider a hazard.

* The Authority Having Jurisdiction (AHJ) is the City or County Department of Building and Safety or Authorized Representative.

(10) Miscellaneous Requirements

10.5 Meter Lock Ring Removal Process

- Unauthorized tampering of SCE-owned seals is prohibited. Seals shall only be broken and installed by SCE's authorized employees, per [Rule 16 D.1.f](#).
- To facilitate requests and prevent customer complaints, all lock ring removals must be authorized by the customer of record or a customer authorized party using one of the following methods
 - Scheduling an appointment for SCE to perform work on their service panel by calling the SCE Customer Contact Center at (800) 655-4555.
 - Having the customer of record complete and submit a third-party Customer Information Service Request (CISR) form ([14-796](#)), allowing the authorized third party to contact SCE to schedule work on the customer's service panel. Keep a copy of the form for your records. Completed forms may be submitted to 3rdParty@sce.com. Questions regarding the third-party authorization form may be directed to SCE's 3rd Party Authorizations at (844) 235-2068.

NOTE: The CISR form must be approved before a third-party may act on behalf of a customer

(11) DEFINITIONS

11.1 Definitions

Accessible: A device that is accessible to SCE maintenance personnel consistent with [Rule 21](#) (PDF) requirements.

Anti-Islanding: A control scheme installed as part of the Generating or Interconnection Facility that senses and prevents the formation of an [Unintended Island](#).

Island; Islanding: A condition on SCE's Distribution System in which one or more Generating Facilities deliver power to customers using a portion of SCE's Distribution System that is electrically isolated from the remainder of SCE's Distribution System.

Line-Side Tap: A point of interconnection on the utility, or line side of the main breaker.

Load-Side Tap: A point of interconnection on the customer, or load side of the main breaker.

Lockable: The disconnect must have provisions for a common 3/8" padlock, used as part of the normal SCE maintenance lockout procedure (see [Section 5](#) Manual, Visibly Open and Lockable AC Disconnect Switch).

Non-Islanding: Designed to detect and disconnect from a stable [Unintended Island](#) with matched load and generation. Reliance solely on under/over voltage and frequency trip is not considered sufficient to qualify as Non-Islanding.

Non-Self Contained Meter: An SCE revenue grade meter at a customer panel that uses external current transformers to measure the flow of current.

Premises: All of the real property and apparatus employed in a single enterprise on an integral parcel of land undivided, excepting in the case of industrial, agricultural, oil field, resort enterprises, and public or quasi-public institutions, by a dedicated street, highway, or other public thoroughfare, or a railway. Automobile parking lots constituting a part of and adjacent to a single enterprise may be separated by an alley from the remainder of the premises served.

Smart Inverter: A Generating Facility's Inverter that performs functions that when activated can autonomously contribute to grid support during excursions from normal operating voltage and frequency system conditions by providing dynamic reactive/real power support, voltage and frequency ride-through, ramp rate controls, communication systems with ability to accept external commands and other functions.

Unintended Island: The creation of an [Island](#), usually following a loss of a portion of SCE's Distribution System, without the approval of SCE.

Visible Open: Visible means visible break; when the disconnect is in the open position, there is a visible separation between the contacts, and the separation may be observed without disassembling the device. Typically, this switch contains visible blades inside an enclosure, an external lever, and a positive indication that the switch is in the off position (see [Section 5](#) Manual, Visibly Open and Lockable AC Disconnect Switch).

(11) Definitions

11.2 Acronyms

A list of commonly used acronyms related to generation interconnections is located below for your reference. Please note, some of these acronyms may not apply to NEM interconnections or have other definitions not listed herein.

AHJ	Authority Having Jurisdiction
AMR	Advanced Metering Request
CCA	Community Choice Aggregation
CEC	California Energy Commission
CPIS	Customer Project Information Sheet
CPUC	California Public Utility Commission
CRD	Certification Requirements Document
CSI	California Solar Initiative
DER	Distributed Energy Resources
EMS	Energy Management System
ERP	Emerging Renewable Program
ESD	Energy Storage Device
ESP	Electric Service Provider
ESR	Electric Service Requirements
ESS	Energy Storage System
GMA	Generation Meter Adapter
IFFOA	Interconnection Facilities Financing and Ownership Agreement
IR	Interconnection Request
MASH	Multifamily Affordable Solar Housing
MCP	Measurement Control Point
MSR	Meter Service Request
MT	Meter Technician OR Multi-Tariff
NBC	Non-Bypassable Charges
NEC	National Electric Code
NEMIC	Net Energy Metering Interconnection
NFPA	National Fire Protection Association
NGOM	Net Generation Output Meter
NRTL	Nationally Recognized Testing Laboratory

(11) Definitions

NSC	Net Surplus Compensation
NSCR	Net Surplus Compensation Rate
NST	NEM Successor Tariff
OASIS	Open Access Same-time Information System
OAT	Otherwise Applicable Tariff
PCC	Point of Common Coupling
PMRS	Performance Monitoring and Reporting System
PTO	Permission to Operate
RCS-G	Remote Control Switch Generation
RECs	Renewable Energy Credits
REGF	Renewable Electrical Generating Facility
RPP	Reactive Power Priority
RPS	Renewables Portfolio Standard
SASH	Single-family Affordable Solar Homes
SDP	Service Delivery Point
SGIP	Self-Generating Incentive Program
SLA	Service Letter Agreement
SOMAH	Solar on Multifamily Affordable Housing
TOU	Time of Use
VNM	Virtual Net Metering
WDAT	Wholesale Distribution Access Tariff

Appendix A: Sample Single Line Diagram

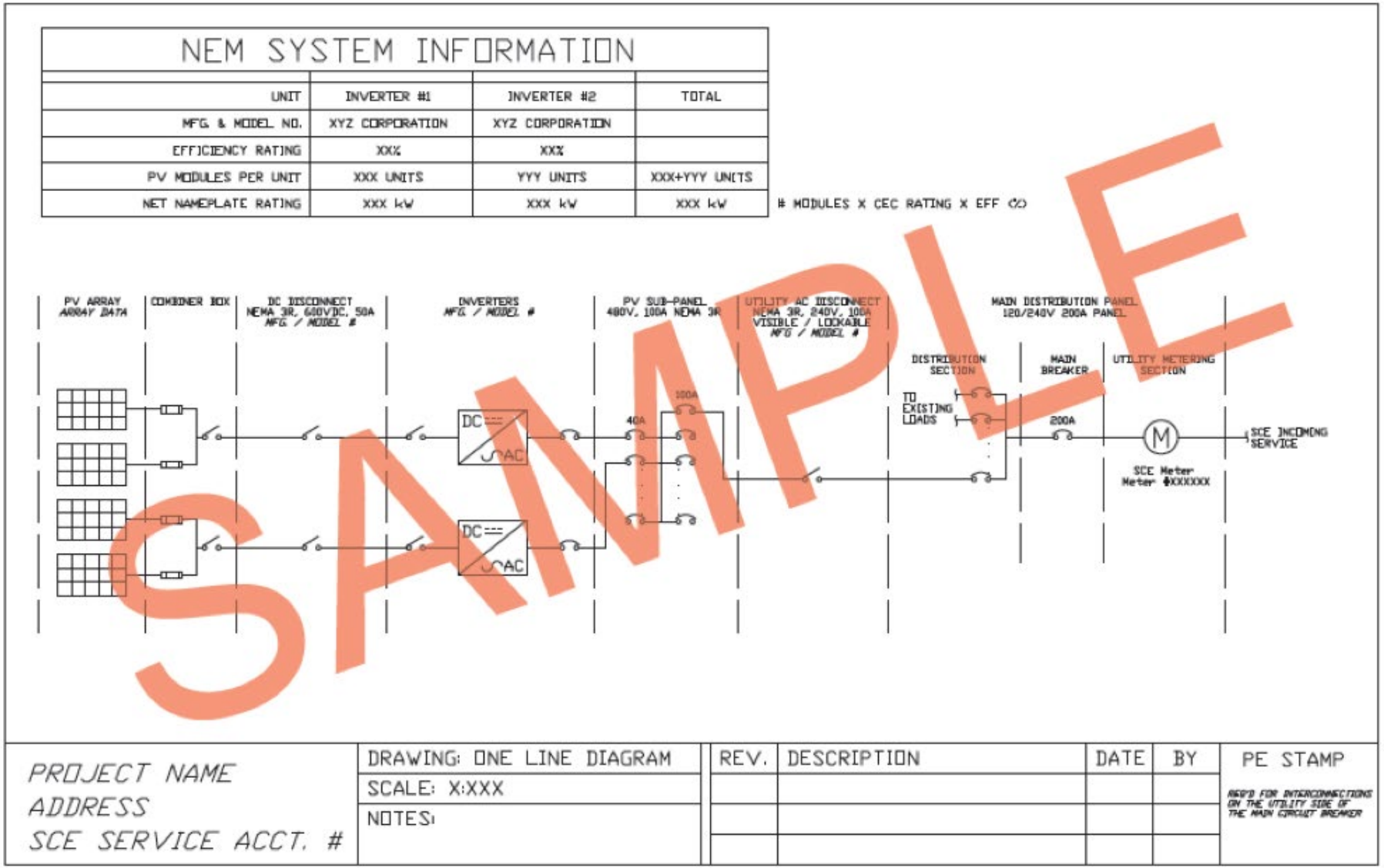

Appendix B: Sample Single line Diagram for GMA installations

NEM SYSTEM INFORMATION			
Unit	Inverter # 1	Inverter # 2	Total
MFG & Model	XYZ Corporation	XYZ Corporation	
Efficiency Rating	XX %	XX %	
PV Modules Per Unit	XXX UNITS	XXX UNITS	XXX + YYY UNITS
Net Nameplate Rating	XXX Kw	XXX Kw	XXX kW # MODULE x CEC RATING x EFF

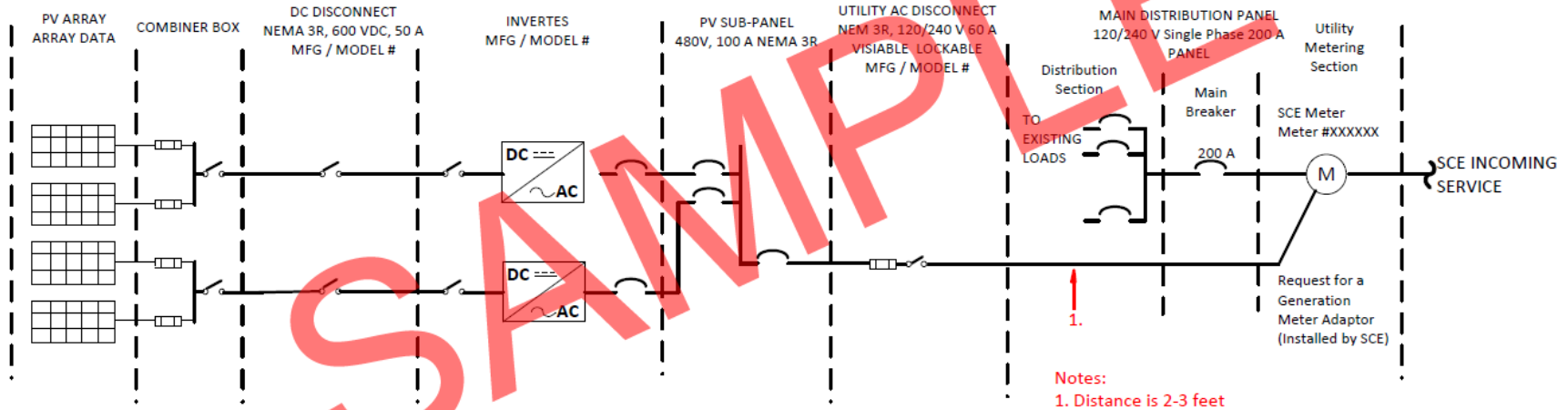

Notes:
1. Distance is 2-3 feet

PROJECT NAME ADDRESS SCE SERVICE ACCT. #	DRAWING: ONE LINE DIAGRAM	REV.	DESCRIPTION	DATE	BY	
	SCALE: X:XXX					
	NOTES:					

Appendix C: Sample Plot Plan

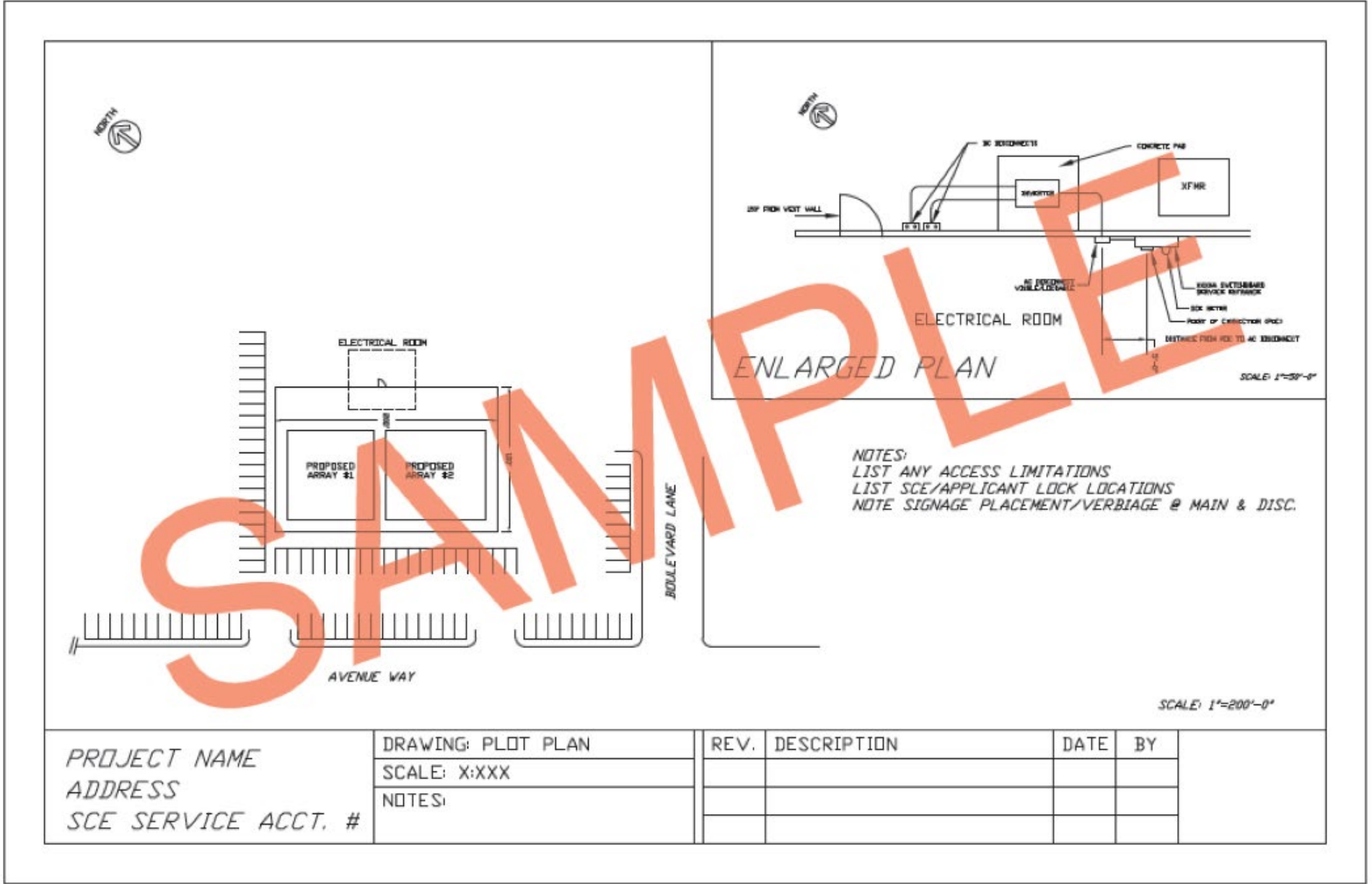

PROJECT NAME ADDRESS SCE SERVICE ACCT. #	DRAWING: PLOT PLAN	REV.	DESCRIPTION	DATE	BY
	SCALE: X:XXX				
	NOTES:				

Appendix D: Inverter Settings Request

[Insert Company Letterhead]

Inverter Settings Validation

Date: MM/DD/YYYY

Installation Address: XXXXX

Project Number: XXXXX

To Whom It May Concern,

This letter is to confirm that all the [Manufacturer Name] [Type of Inverters] with [Serial Number] were installed and configured in accordance to California's Rule 21 section Hh requirements., and a commissioning test was performed as required by Rule 21 Section L.5.a.

The following functions were activated, and default settings were not adjusted unless required to be in accordance with California's Rule 21 section Hh requirements.

SA	Function	State
SA 8	Anti-islanding	Activated
SA 9	Low/High Voltage Ride Through	Activated
SA 10	Low/High Frequency Ride Through	Activated
SA 13	Dynamic Volt/Var Operations (RPP)	Activated
SA 11	Ramp Rates/Reconnect by "soft-start" methods	Activated
SA 12	Fixed Power Factor	Deactivated
SA 14	Frequency/Watt	Activated
SA 15	Volt/Watt	Activated

Signature of Manufacturer or Installer
Name, Title
Company
Contact Information

Appendix E: Maximum Borderline of Irritation Curve

VOLTAGE FLUCTUATION DESIGN LIMITS SOUTHERN CALIFORNIA EDISON COMPANY CRITERIA MAY 1994

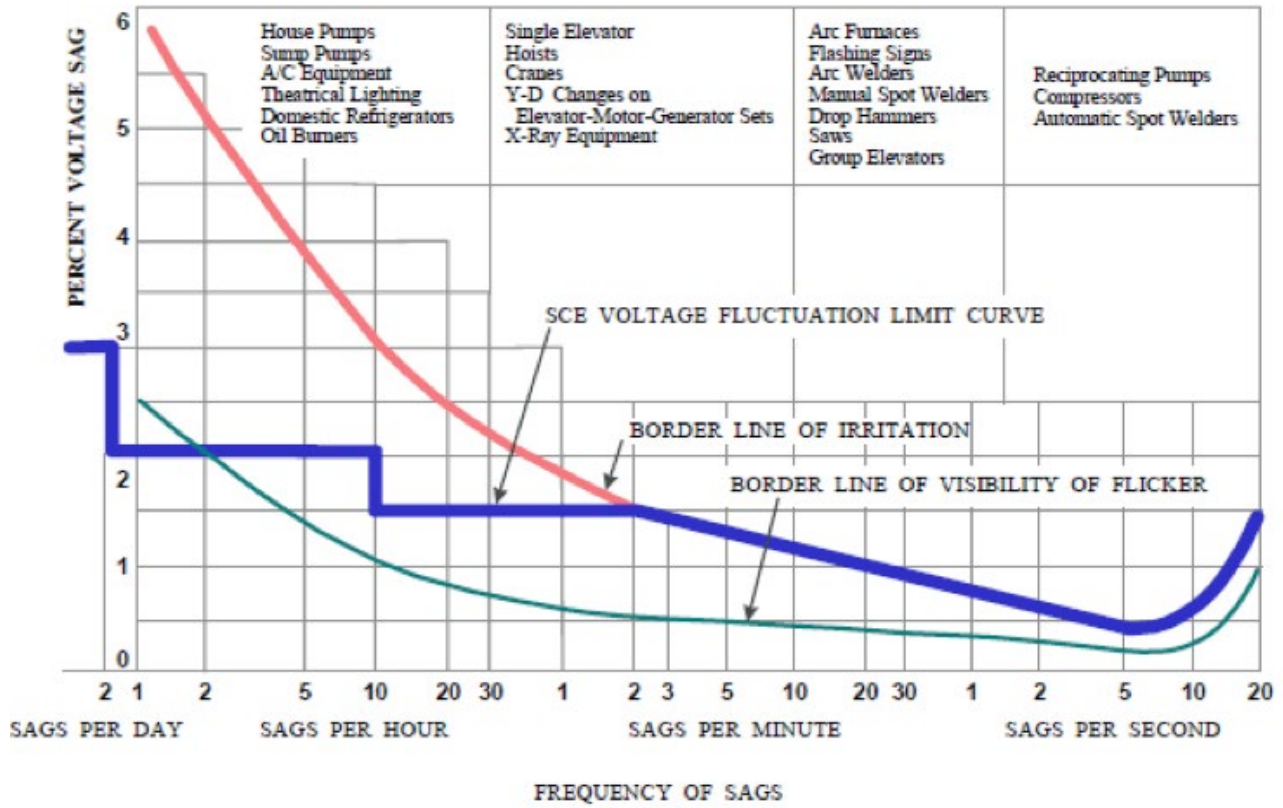

Appendix F: Supply Side / Line Side connections



To: _____ SCE Project #: _____

SCE has received the application for a ___kW solar generating facility located at _____.

The single line for the proposed project indicates that the proposed method of interconnection to the SCE system is to connect the generating facility to the source side of the existing customer's main breaker (Line Side Tap). This proposed method of interconnection requires the existing interconnecting customer's electrical service equipment, (busses, connectors, termination points, cables, etc.) to be modified in order to connect the generation on the source side of the customer's main circuit breaker. Such modifications could compromise the UL certification of the existing customer's electrical service equipment and could compromise the ratings and withstand capabilities that the customer's electrical service equipment was originally designed for. SCE strongly encourages the customer to modify its proposed method of interconnection, and interconnect the generating facility to the load side of the main circuit breaker in accordance with the original intent of the existing electrical service equipment.

SCE considers the project's proposed method of interconnection to be a potential safety issue because of the modification of the customer's electrical service equipment. To ensure that the project's interconnection facilities meet SCE's safety requirements, SCE must receive verification of UL compliance for the modifications to the existing electrical service equipment. This can be accomplished in the following ways:

1. A copy of the attached verification signed by the inspecting authority, acknowledging the following: (1) that the existing customer's electrical service equipment has been altered to allow the interconnection of the generating facility to the source side of the customer's main breaker; and (2) that the altered electrical service equipment continues to meet UL certification requirements or that the modified equipment has been recertified for its new configuration.
2. A document from the manufacturer of the existing electrical equipment indicating that the proposed modification or connection to the source side of that panel does not compromise the UL rating of the panel.
3. A UL certification of the proposed modification or connection to the source side of the customer's main circuit breaker of the existing electrical equipment.
4. A Nationally Recognized Testing Laboratory (NRTL) certification of the proposed modification or connection to the source side of the customer's main circuit breaker. [Link to site](#)

5. A Field Evaluation Body (FEB) equipment evaluation report of the supply side connection including but not limited to, busses, connectors, termination points and cables has been inspected and certified. The FEB shall be recognized by the International Accreditation Service listings - [Link to site](#)

SCE must receive one of these verifications before it will approve the generating facility for interconnection to SCE's Distribution System via the source side of the existing customer's main breaker (Line Side Tap). It should be noted that in addition to the requirements above, the customer must comply with other existing requirements including a P.E. stamped Single Line, plot plan, equipment requirement, etc.

Return to:
Southern California Edison
Assigned Field Engineer

City / Authority Having Jurisdiction: _____

SCE Project #: _____

I, _____, hereby certify that:

1. The existing customer's electrical service equipment has been altered to allow the interconnection of the generating facility to the source side of the customer's main breaker; and
2. The altered electrical service equipment continues to meet UL certification requirements or that the modified equipment has been recertified for its new configuration.

Name & Title: _____ Signature: _____ Date: _____

Appendix G: Net Generation Output Meter (NGOM) Panel EUSERC Drawing Number Guide Table

NOTE: It is the Generation Interconnection Customer's responsibility to adhere to SCE ESR and verify the panel option meets the project metering needs prior to starting construction. Reference this NGOM Panel EUSERC Drawing Number Guide Table as well as the Reference List of SCE-Approved EUSERC Drawings found in the SCE ESR (drawings marked as "Reference Only" are applicable to installed legacy equipment).

WireNet Generating Output Meter (NGOM) Panel EUSERC Drawing Number Guide Table			
Type of Service/ Voltage	Panel Rating Options (Continuous Current Rating in Amps)	Panel Type	Typical EUSERC Drawing Numbers. For additional options, consult SCE ESR Table 9-1: Reference List of SCE-Approved EUSERC Drawings
Single-Phase, 120/240 V, 3-Wire	100A, 200A	Non-CT Rated (Self-contained)	301 304 (100A only) 305 (200A only) 305A*
	400A (Class 320)	Non-CT Rated (Self-contained)	302A
	Greater than 200A	CT-Rated	313 (400A Maximum) 314 (400A Maximum)
Single-Phase, 120/208 V, 3-Wire	100A, 200A	Non-CT Rated (Self-contained)	304 (100A only) 305 (200A only) 305A*
	Greater than 200A	CT-Rated	313 (400A Maximum) 314 (400A Maximum)
Existing: Single- Phase, 277/480 V, 3-Wire	100A, 200A	Non-CT Rated (Self-contained)	304 (100A only) 305 (200A only) 305A
	400A - 800A	CT-Rated	313 (400A Maximum) 314 (400A Maximum)
New Service: Three-Phase 277/480 4-Wire	100A, 200A	Non-CT Rated (Self-contained)	304 (100A only) 305 (200A only) 305A*
	400A - 1200A	CT-Rated	313 (400A Maximum) 314 (400A Maximum)
Three-Phase, 480 V, 3-Wire	100A, 200A	Non-CT Rated (Self-contained)	304 (100A only) 305 (200A only) 305A*
	400A - 1200A	CT-Rated	313 (400A Maximum) 314 (400A Maximum)
Three-Phase, 120/208 V, 4-Wire	100A, 200A	Non-CT Rated (Self-contained)	304 (100A only) 305 (200A only) 305A*
	400A - 800A	CT-Rated	313 (400A Maximum) 314 (400A Maximum)
Three-Phase, 277/480 V, 4-Wire	100A, 200A	Non-CT Rated (Self-contained)	304 (100A only) 305 (200A only) 305A*
	400A-1200A	CT-Rated	313 (400A Maximum) 314 (400A Maximum)

*Visit EUSERC.org for detailed technical requirements.